

MDD/MDP SWITCH

CONVERSION INSTRUCTIONS



PLEASE READ CAREFULLY BEFORE INSTALLATION!

Version: 1.4 EN; item number: 00602-3-026





TABLE OF CONTENTS

1	INSTALLATION OF THE SWITCH / STICKER	3
1.1	Installation of the adapter plate.....	3
1.2	Switch position sticker	3
1.3	Removing the lid.....	4
1.4	Removing the spreading plate / fan connection	4
2	CABLING	4
2.1	Cabling for the spreading plate motor (output).....	4
2.2	Cabling for the fan motor (output).....	5
2.3	Cabling for the switch (input)	5
2.4	Installation on the MD	6
2.5	Installation of the switch and lid	6
3	SETTINGS.....	7
3.1	Spreading plate switch position	7
3.2	Fan switch position	7
3.3	Settings on control box 5.2	8
4	MDD / MDP CONNECTION DIAGRAM	8
5	TOGGLE SWITCH CONNECTION DIAGRAM	10

1 INSTALLATION OF THE SWITCH / STICKER

1.1 INSTALLATION OF THE ADAPTER PLATE



Install the adapter plate with the four countersunk tapping head screws (BN995-2.9x13) on the switch (Figure 1).

Figure 1

1.2 SWITCH POSITION STICKER



Apply the sticker with the switch positions over the existing holes on the Multi-Metering System (Figure 2).

Figure 2

1.3 REMOVING THE LID

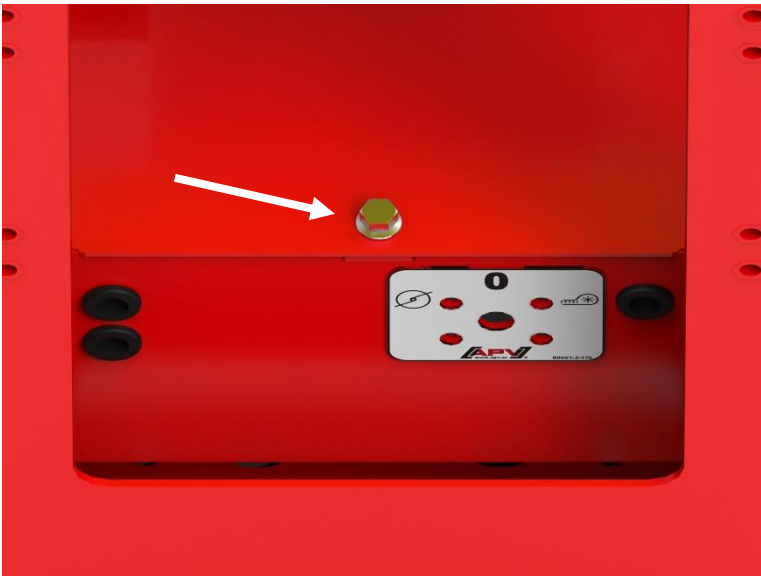

Remove the lid by loosening the hexagonal bolt (width across flats 10) and fold away the lid upwards (Figure 3).

Figure 3

1.4 REMOVING THE SPREADING PLATE / FAN CONNECTION

Depending on whether you have an MDD (with spreading plate) or an MDP (with elec. fan), you must disconnect the spreading plate or fan connection cable from the terminal strip.

2 CABLING

2.1 CABLING FOR THE SPREADING PLATE MOTOR (OUTPUT)

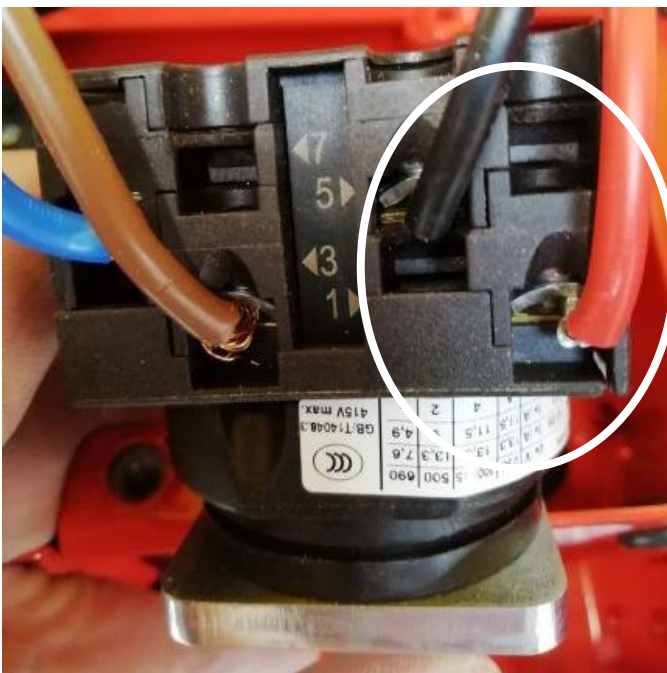

Connect the connection cable for the spreading plate motor to the switch.
BLACK to 5
RED to 1
(Figure 4)

Figure 4

2.2 CABLING FOR THE FAN MOTOR (OUTPUT)



Connect the connection cable for the fan motor to the switch.
BLUE to 7
BROWN to 3
(Figure 5)

Figure 5

2.3 CABLING FOR THE SWITCH (INPUT)

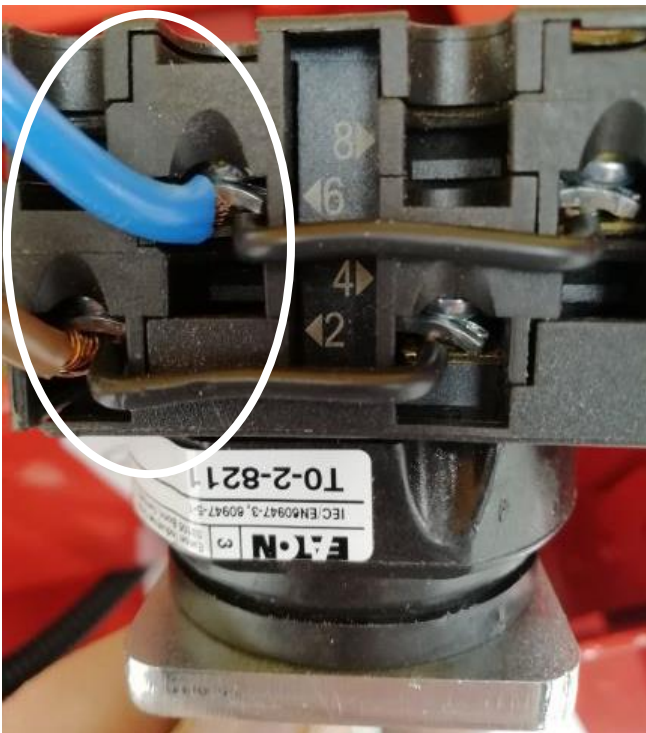

Connect the supplied connection cable to the switch.
BLUE to 6
BROWN to 2
(Figure 6)

Figure 6

CAUTION!

To ensure a firm hold of the connection cable on the toggle switch, strip the cable insulation (approx. 1 cm) from the cable and do NOT twist the individual strands with each other before you connect the two cable ends to the toggle switch.

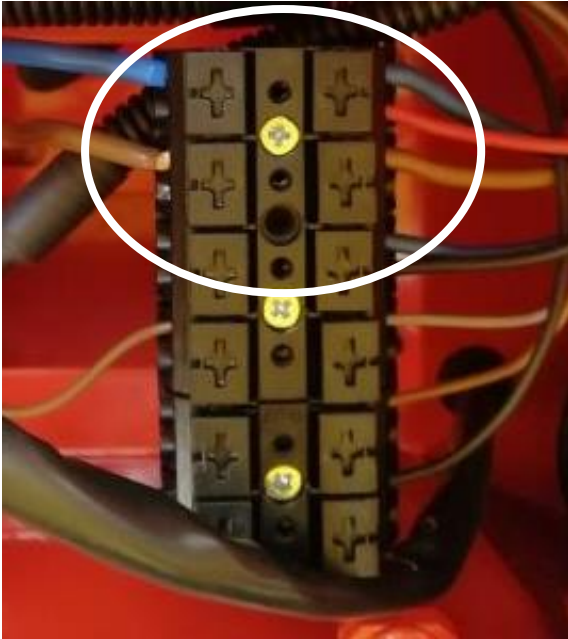

Figure 7

Connect the second end of the connection cable to the terminal block – where the fan of the spreading plate was previously connected.
 BLUE to 1 (opposite to BLUE of the implement cable)
 BROWN to 2 (opposite to BROWN of the implement cable)
 (Figure 7)

2.4 INSTALLATION ON THE MD



Figure 8

Insert the shaft of the switch, with the previously connected cables pointing down, through the frame from the inside of the Multi-Metering System. Then fasten it onto the frame with the four round-head screws.
 (Figure 8)

2.5 INSTALLATION OF THE SWITCH AND LID

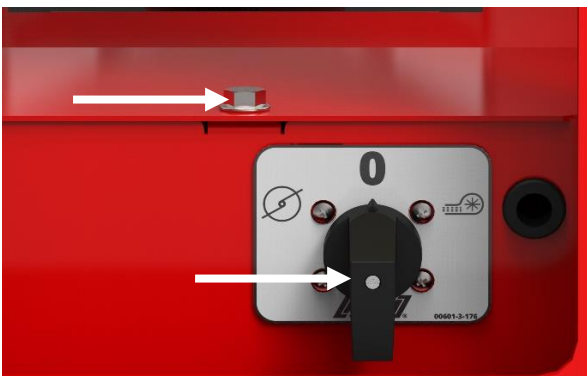

Figure 9

Put the switching lever on the shaft of the switch and fasten it with the bolt in the middle.
 Install the lid with the previously removed hexagonal bolt.
 (Figure 9)

3 SETTINGS

3.1 SPREADING PLATE SWITCH POSITION



Figure 10

In this switch position, the spreading plate motor is actuated.

When this switch position is selected, the implement type "MDD" must be selected in the programming menu of the control box. (Figure 10)

3.2 FAN SWITCH POSITION



Figure 11

With this switch position, the fan motor is actuated.

When this switch position is selected, the implement type "MDP" must be selected in the programming menu of the control box. (Figure 11)





3.3 SETTINGS ON CONTROL BOX 5.2



Figure 12

To call up the Programming menu in older software versions (up to V1.26), the OK button and both arrow buttons must be pressed simultaneously during the start-up process until the Customer Service menu appears. (Figure 12)

For software versions V1.27 and higher, only the On/Off button must be pressed and held for approx. 5 seconds.

Button	Designation	Function
	On/Off button	Switching the Control Box on/off and calling up the Programming menu.
	Arrow buttons Up arrow button (▲) Down arrow button (▼)	Scrolling in the programming menu.
	Plus/minus buttons	Changing the parameter.
	OK button	Finishing and confirming the programming.



NOTE!

If a value was changed in the programming menu and you exit the programming menu, the control box switches itself off automatically. You must then start the control box to accept the changed settings.

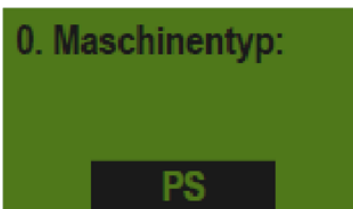

Figure 13

Select the implement type for which you want to enter the settings.
→ MDP, MDG, MDD.
(Figure 13)

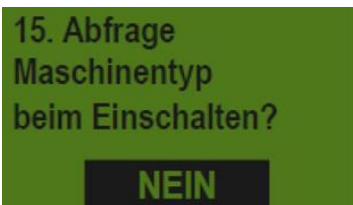

Figure 14

Here, you can set whether the control box should request the used implement type (PS, MDP, MDG, MDS) every time the control box is switched on.
(Figure 14)



NOTE!

If you are using the same control box to operate different implement types, you therefore do not need to enter the programming menu every time to change the type.

4 MDD / MDP CONNECTION DIAGRAM

Anschlussplan MD

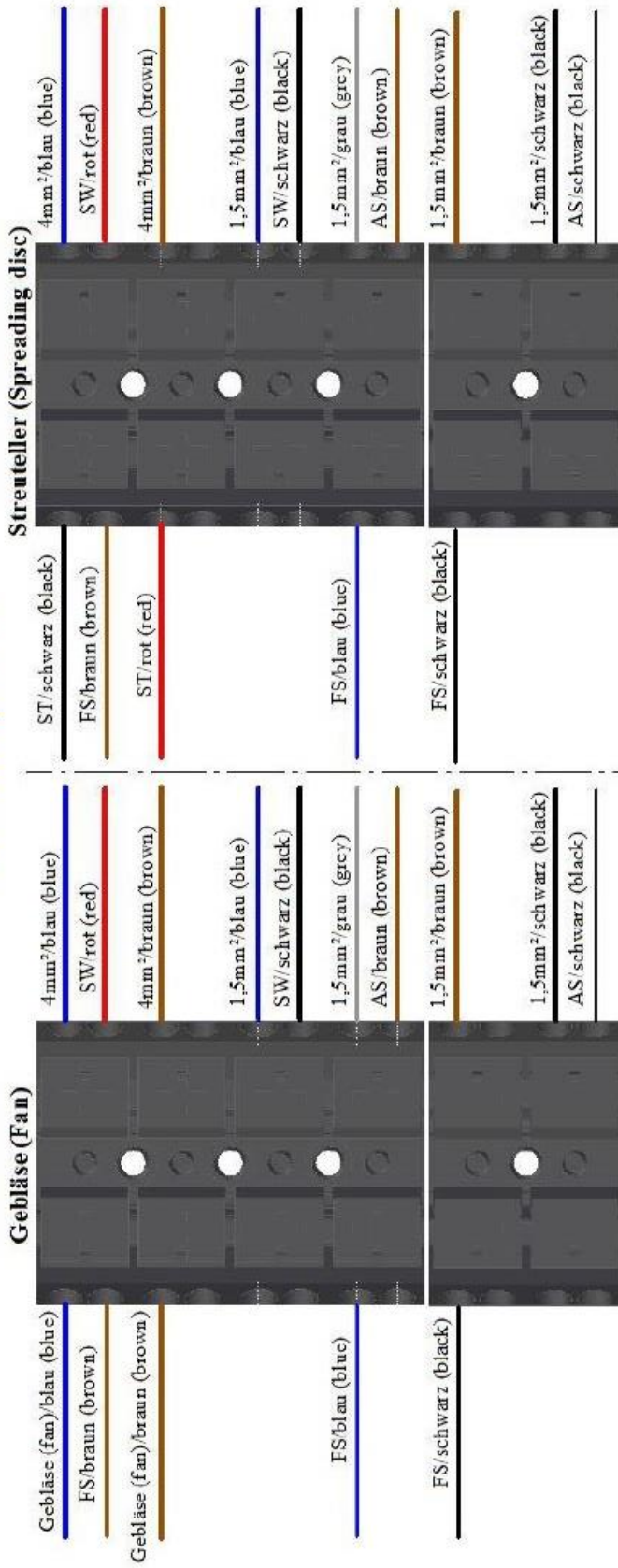

Stecker-Pin (plug-Pin)	Gerätekabel (machine cable)	Gebläse (fan)	Streuteller (ST) (spreader disc)	Säwellenmotor (SW) (sowing shaft motor)	Füllstandsensor (FS) (fill level sensor)	Abdrehschalter (AS) (calibration button)
1	4 mm ² / blau (blue)	4 mm ² / blau (blue)	2,5 mm ² / schwarz (black)	1,5 mm ² / rot (red)	0,75 mm ² / braun (brown)	
2	4 mm ² / braun (brown)	4 mm ² / braun (brown)	2,5 mm ² / rot (red)			
3	1,5 mm ² / blau (blue)			1,5 mm ² / schwarz (black)		
4	1,5 mm ² / grau (grey)				0,75 mm ² / blau (blue)	0,75 mm ² / braun (brown)
5	1,5 mm ² / braun (brown)				0,75 mm ² / schwarz (black)	
6	1,5 mm ² / schwarz (black)					0,75 mm ² / schwarz (black)

Figure 15

5 TOGGLE SWITCH CONNECTION DIAGRAM

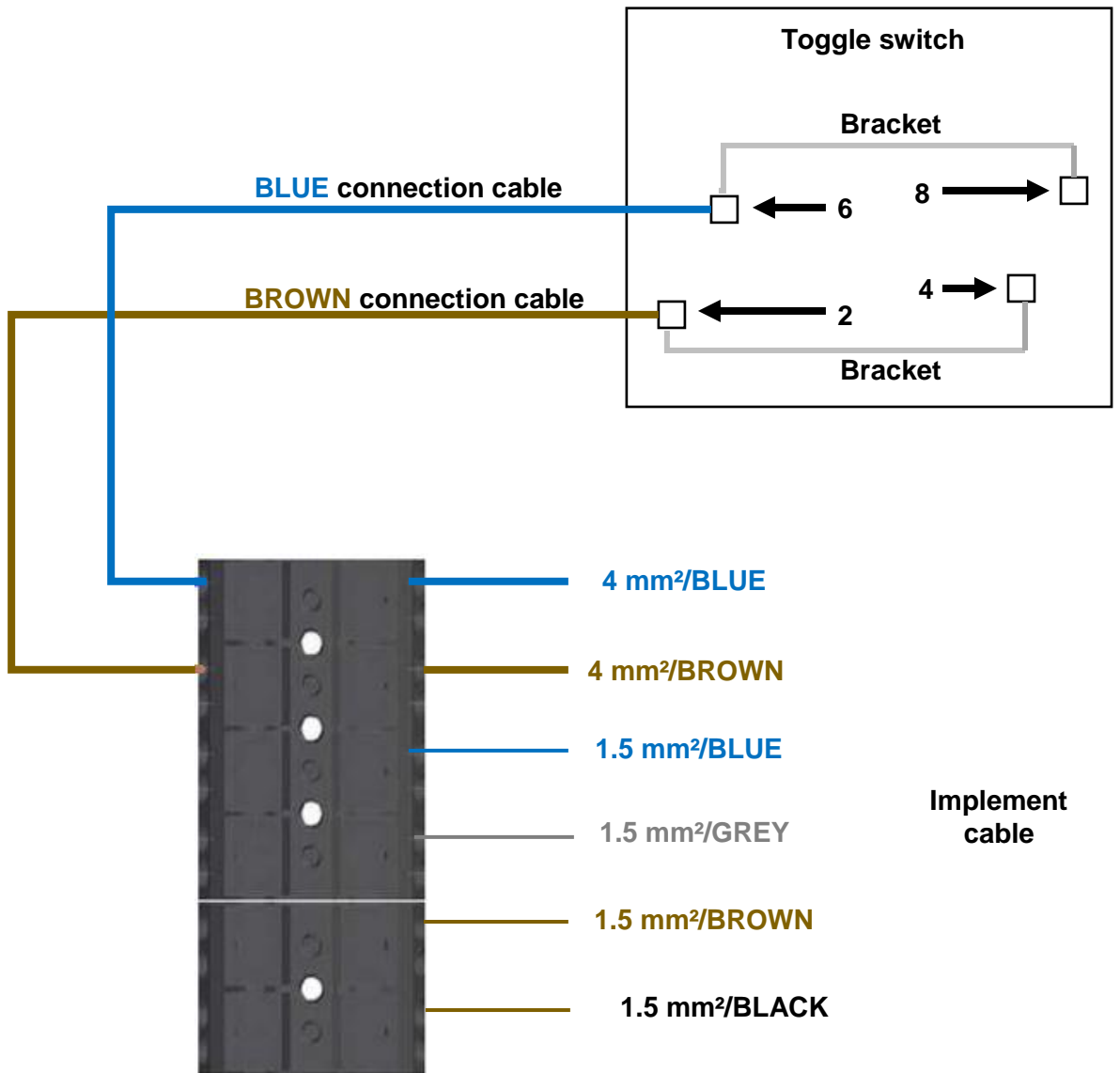
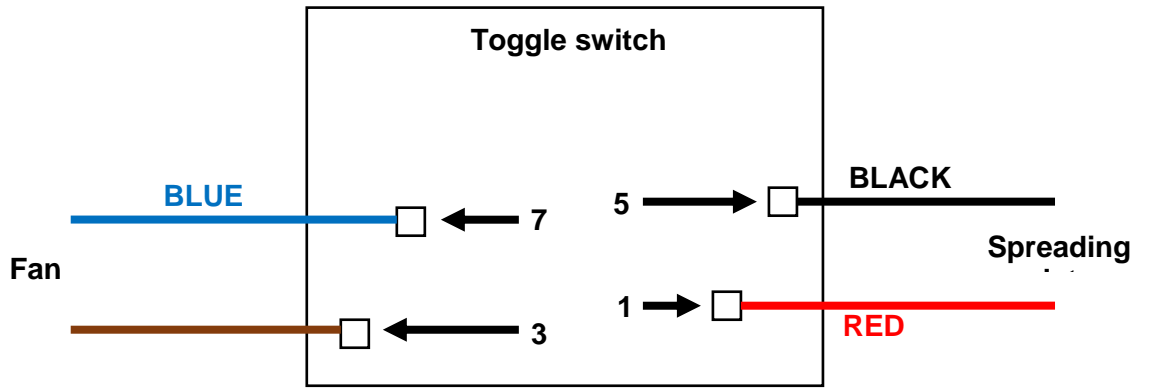

Figure 16



APV – Technische Produkte GmbH
Zentrale: Dallein 15
AT - 3753 Hötzelndorf

Tel.: +43 2913 8001
office@apv.at
www.apv.at

