

GRASSLAND PRO HARROW

GP 600 M2

OPERATING MANUAL



PLEASE READ CAREFULLY BEFORE INITIAL OPERATION

Translation of the original operating manual

Version: 2.3 EN; item number: 00602-3-775



TABLE OF CONTENTS

1	EC DECLARATION OF CONFORMITY	4
2	UK CONFORMITY ASSESSED	5
3	IDENTIFICATION OF THE IMPLEMENT	6
4	SERVICE	6
5	WARRANTY	7
5.1	Warranty activation	7
6	SAFETY INFORMATION	7
6.1	Intended use	7
6.2	General safety-related instructions and accident prevention regulations	8
6.3	Mounted implements	10
6.4	Hydraulic system	10
6.5	Maintenance	10
6.6	Tyres	11
6.6.1	Load index and speed index	11
6.7	Mounted seeders	12
6.7.1	Filling the seeder	12
6.8	Danger areas	12
6.8.1	Danger areas during implement operation	13
6.8.2	Danger areas when folding and unfolding	14
6.9	Residual hazards	14
6.9.1	Danger from mechanical systems	14
6.9.2	Danger from hydraulic systems	14
6.9.3	Dangers arising from operation	15
7	INFORMATION SIGNS / HAZARD LABELS	15
7.1	Information signs	15
7.2	Hazard labels	17
7.3	Placement of the hazard labels and other signs	18
8	OPERATING MANUAL	19
8.1	Layout and mode of operation	19
8.2	Mounting and dismounting the implement	20
8.2.1	General information	20
8.2.2	Parking brake	20
8.2.3	Coupling	20
8.2.4	Uncoupling	21
8.3	Unfolding from transport position to working position	22
8.4	Folding from working position into transport position	23
8.5	Working position and setting the working depth	23
8.5.1	Depth setting / drawbar adjustment	23
8.5.2	Adjusting the series of holes	24
8.6	Using individual tools	24
8.7	Levelling plate	24
8.8	Coupling and uncoupling the roller	25
8.9	Folding lock	26
8.10	Turning on the headland	27
8.10.1	Turning with roller	27
8.10.2	Turning with chassis	27
8.11	Loading and unloading on a low-loader	27

9	ASSISTANCE IN CASE OF MALFUNCTIONS.....	28
9.1	Procedure in case of malfunctions or errors	28
10	MAINTENANCE AND CARE	28
10.1	General maintenance instructions.....	28
10.2	Instructions for regular maintenance	28
10.3	Changing the tines	29
10.4	Tine safety	30
10.5	Lubrication schedule	30
10.6	Repairs and service	31
11	INFORMATION ON NATURE CONSERVATION AND ENVIRONMENTAL PROTECTION	32
12	TECHNICAL DATA.....	32
13	POSSIBLE COMBINATIONS WITH A PNEUMATIC SEEDER	33
14	ROAD TRANSPORT	33
14.1	Transport on public roads (general information)	33
15	LIGHTING CIRCUIT DIAGRAM.....	35
16	DECOMMISSIONING, STORAGE AND DISPOSAL.....	35
16.1	Decommissioning the implement	35
16.2	Storage of the implement	35
16.3	Disposal.....	36
17	CROP CULTIVATION TIPS FOR USE OF THE GRASSLAND PRO HARROW	36
18	ACCESSORIES	37
18.1	Equipment kit for operation on public traffic areas.....	37
18.1.1	Compressed air system	37
18.1.2	Wheel chocks	39
18.1.3	Tine sections cover	39
18.1.4	Lighting with warning signs (on both sides)	39
18.1.5	Mudguard.....	40
18.1.6	Anti-theft device	40
18.2	Mounting kit for PS200 - 500.....	40
18.3	Dispersion plate installation	40
18.4	Mounting kit for PS 800.....	40
18.5	Platform kit.....	41
18.6	Changeover valve for operating two hydraulic functions.....	41
18.7	Toolbox.....	41
18.8	Sensor set: GPSa + linkage sensor	41
18.9	Feeler wheel mounting kit	42
19	SPARE PARTS.....	43
20	INDEX	43

1 EC DECLARATION OF CONFORMITY



in compliance with EC Machinery Directive 2006/42/EC



APV Technische Produkte GmbH
Dallein 15
A-3753 Hötzelsdorf

hereby declares that the mounted implement described in the following complies with the applicable basic safety and health requirements of the above-mentioned Directives in terms of its concept and design as well as the versions put on the market.

This declaration loses its validity if there are any changes to the mounted implement that are not approved by **APV Technische Produkte GmbH**.

Designation of the mounted implement:
GRASSLAND PRO HARROW GP 600 M2

Year of manufacture: as of **2022**

Serial numbers: as of 06028-01000

Relevant EC Directives:
Directive for machinery – Machinery Directive 2006/42/EC

For the planing, design, construction and marketing of the "Grassland Pro Harrow GP 600 M2" mounted implement, the following harmonised European standards were applied in addition to the Directives, in particular:

- EN ISO 12100:2010 – Safety of machinery, general principles for risk assessment
- EN ISO 13857:2020 – Safety distances to prevent hazard zones being reached by upper and lower limbs
- EN ISO 13849-1:2015 – Safety of machinery – Safety-related parts of control systems

Responsible for the technical documentation: Planning and Design department, Dallein 15

Ing. Jürgen Schöls
Managing Director
(authorised person in the EU)

Dallein/Hötzelsdorf, 10.11.2022

2 UK CONFORMITY ASSESSED

in compliance with EC Machinery Directive 2006/42/EC



APV Technische Produkte GmbH
Dallein 15
A-3753 Hötzelstdorf

hereby declares that the mounted implement described in the following complies with the applicable basic safety and health requirements of the above-mentioned Directives in terms of its concept and design as well as the versions put on the market.

This declaration loses its validity if there are any changes to the mounted implement that are not approved by **APV Technische Produkte GmbH**.

Designation of the mounted implement:
GRASSLAND PRO HARROW GP 600 M2

Year of manufacture: as of **2022**

Serial numbers: as of 06028-01000

Relevant EC Directives:
Directive for machinery – Machinery Directive 2006/42/EC

For the planing, design, construction and marketing of the "Grassland Pro Harrow GP 600 M2" mounted implement, the following harmonised European standards were applied in addition to the Directives, in particular:

- EN ISO 12100:2010 – Safety of machinery, general principles for risk assessment
- EN ISO 13857:2020 – Safety distances to prevent hazard zones being reached by upper and lower limbs
- EN ISO 13849-1:2015 – Safety of machinery – Safety-related parts of control systems

Responsible for the technical documentation: Planning and Design department, Dallein 15

A handwritten signature in black ink, appearing to read 'Jürgen Schöls', written in a cursive style.

Ing. Jürgen Schöls
Managing Director
(authorised person in the EU)

Dallein/Hötzelstdorf, 10.11.2022

3 IDENTIFICATION OF THE IMPLEMENT

The Grassland Pro Harrow can be clearly identified by the following information on the type plate:

- Designation
- Model
- Vehicle class
- Vehicle ID number

Position of the type plate

The type plate is located on the right of the centre frame (see Figure 1).

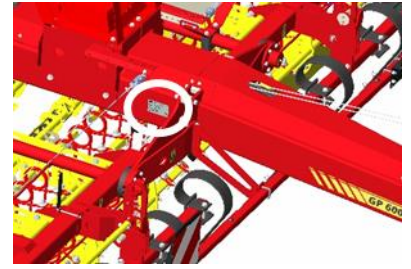

Figure 1

The following image (Figure 2) shows the layout of the type plate.



The data on the type plate have the following meaning:

- 1: Designation
- 2: Model
- 3: Vehicle class
- 4: EU type approval no.
- 5: Vehicle ID no.
- 6: Axle load and drawbar load

Figure 2



PLEASE NOTE!

In cases of inquiries or warranty claims, please always tell us the production number/serial number of your implement.

4 SERVICE

Please contact our service address in the following cases:

- If you still have questions regarding the handling of this implement despite the information provided in this operating manual
- For questions regarding spare parts
- To order maintenance and servicing work

Service address:

APV Technische Produkte GmbH
Zentrale: Dallein 15
A-3753 Hötelsdorf
AUSTRIA

Telephone: +43 2913 8001-5500
Fax: +43 2913 8002
Email: service@apv.at
Web: www.apv.at

5 WARRANTY

Please check the implement for any transport damage immediately upon receipt. Later claims regarding transport damage can no longer be considered.

Based on a warranty activation (see Point 5.1), we grant a six-month factory warranty starting on the date of initial operation (your invoice is the warranty certificate).

This warranty is applicable for cases of material or construction faults and does not include parts that are damaged by normal or excessive wear.

The warranty expires

- if damage is caused by external forces.
- in cases of operating errors.
- if the kW/HP limits are significantly exceeded.
- if the implement is modified, expanded or equipped with third-party spare parts without our permission.

5.1 WARRANTY ACTIVATION

Every APV implement must be registered immediately after delivery. The registration activates the claim for warranty services and APV can guarantee the best service.

To activate the warranty for your implement, simply scan the QR code with your smartphone - you will then be taken directly to the service area on our website.



Of course, you can also activate the warranty through our website www.apv.at in the service area.

6 SAFETY INFORMATION

This chapter contains general rules of conduct for the intended use of the implement and safety-related information that should always be observed for your safety.

The list is very extensive, and some of the information does not apply exclusively to the delivered implement. However, the summary of the information often reminds you of unconsciously neglected safety regulations for the everyday operation of machines and implements.

6.1 INTENDED USE

The implement is designed solely for normal use in agricultural operations.

Any other use is considered to be non-intended. The manufacturer is not liable for any resulting damage, the operator alone bears the associated risk.

Intended use also includes compliance with the conditions for operation, maintenance, and repairs prescribed by the manufacturer.

The implement may only be used, maintained and repaired by persons who have relevant experience and were instructed on the risks. The safety instructions must also be handed over to other users.

The applicable, country-specific accident prevention regulations as well as the other generally safety-related, occupational health and road traffic regulations must also be observed.

The manufacturer is not liable for any damage resulting from unauthorised modifications and the use of components and auxiliary parts. This causes the declaration of conformity to lose its validity.

6.2 GENERAL SAFETY-RELATED INSTRUCTIONS AND ACCIDENT PREVENTION REGULATIONS

- The warning and information signs applied to the implement provide important instructions for safe operation. These may not be removed in any case, observe them for the sake of your own safety!
- There are pinch and shear points on externally powered (e.g. hydraulic) parts!
- People must not be carried on the implement during intended use on agricultural land and when driving on roads.
- Triggers for fast couplers must be hanging loosely and must not trigger themselves when lowered.
- Observe the generally applicable safety and accident prevention regulations for the respective country!
- Transport of the implement on public roads requires compliance with the respective national licensing regulations and road traffic regulations.
- When implement parts are moving (e.g. during the folding or pre-tensioning procedure) it must be ensured that there is no one standing in the danger zone of the implement – there is a risk of crushing.
- When using the platform kit, it must be ensured that the implement is at a standstill, is unfolded, and lowered onto the ground.
- When mounting on the towing vehicle, the operator must ensure that the requirements for the tractor in terms of the power, total weight, transport dimensions, axle loads and weight distribution as specified in the operating manual are met and that the connections specified in the operating manual are correctly established.
- When driving through low or narrow obstacles (e.g. power lines, underpasses, etc.), attention must be paid to the height and width of the implement to avoid collisions.
- When driving on public roads, which is only permitted with the chassis extended (both wheels) and with the side wings folded as well as the roller retracted (hydraulic cylinder for roller adjustment is completely retracted), the control block on the chassis cylinder prevents lowering of the Grassland Pro Harrow as well as of the folded up components (additionally secured with catch hooks), also in case of failure of the tractor hydraulic system.
- When driving in curves, take account of the wide radius and/or the centrifugal mass of the implement! Pay attention to the minimum turning curve!
- Additional lighting (e.g., flashlight) should be used for repair or maintenance work if necessary.
- For implements that are driven rapidly with soil-driven tools: Danger after lifting due to the still rotating centrifugal mass! Only approach the implement when it has come to a standstill!
- In case of loss or breakage of implement parts, they must be immediately replaced with original parts by trained specialist personnel.
- When mounting and dismounting, put the support devices in their respective positions (stability)!
- Special care must be taken when coupling and uncoupling implement to and from the tractor!
- Do not use the implement if you are tired or under the influence of drugs, alcohol or medication.
- Climbing onto the implement or walking on the implement is only allowed if a platform kit is installed and the implement is at a standstill.
- The implement may only be used on agricultural land. It may not be used on normal road surfaces, on asphalt or concrete. In particular, the implement may not be used in the building industry on construction sites, for winter services, for road construction, or for underground mining.
- The implement must only be used by competent personnel who are informed of the danger zones and who are familiar with the regulations for transport on public roads. The owner is responsible for regularly monitoring user competence
- The implement is intended for outdoor operation in dry weather, within a temperature range from +5 °C to 40 °C. Water penetration must be avoided. The implement must not be used in rain, thunderstorms and/or stormy conditions and it must be parked under a shelter.
- It is not allowed to carry passengers on the implement during operation and transport!
- Do not transport work materials on the implement, except for seed in the hopper of a possibly mounted Pneumatic Seeder.
- Accessories must be mounted in compliance with the standards by qualified specialist personnel from an authorised company.

- It is forbidden to stand in the working area of the implement!
- The operator/user must ensure that no one is standing in the vicinity of the implement, when it or its components are moved via the tractor hydraulic system or when the roller is being lifted or lowered. Visual check by the driver!
- With initial use of the implement, the operator/user confirms that they have read and fully understood this operating manual.
- When mounting the implement, the operator/user must connect the Grassland Pro Harrow to the tractor by means of a mechanical connection (ensured by the lower link).
- The operator must train and instruct their personnel prior to first use of the implement. Personnel/users must have read and understood the operating manual before handling the implement.
- When mounting the implement, the operator/user must ensure that connections to the tractor hydraulic system are clean and carefully connected.
- The operator/user should wear tight-fitting clothing! Avoid wearing loose clothes!
- The instructions concerning assembly as well as the requirements concerning the tractor as specified in the operating manual are to be observed.
- The forward speed of the tractor may not exceed 12 km/h when performing field passes.
- The implements must be checked regularly by the operator/user (before each use) for any fractures and cracks, chafe marks, leaks, loose bolts and connections, vibrations, unusual noises, and for correct function.
- The view on the mounted implement and the hazardous movement area must be clear to check the procedure.
- Folded frames and lifting devices must be locked in transport position!
- It must be ensured that the hydraulic couplings are not soiled.
- Always wear protective goggles, hearing protection, and tight-fitting protective work gloves when performing coupling tasks (compressed air connections, hydraulic connections, etc.).
- The driving behaviour, steering and braking capacity are affected by mounted or towed implements and ballast weights. For this reason, always ensure sufficient steering and braking capacity!
- When passing on the implement, be sure to pass on the operating manual.
- Always secure the parked implement against unintentional rolling.
- The implement may only be operated when all of the protective devices are installed and in safety position!
- The implement must be coupled according to the instructions and only onto the specified devices!
- Always attach ballast weights at the intended attachment points according to the specifications!
- Always keep the operating manual close to the implement for reference purposes.
- Hydraulic folding frames may only be actuated when nobody is standing in the swivelling range.
- Maintenance, repair, and cleaning work as well as the elimination of malfunctions should always be performed when the drive is switched off, the engine is at a standstill, and after verifying that there is no voltage!
- Inspections must be performed before operation or as part of regular care and maintenance of the implement.
- Do not stand near rotating and swivelling parts of the implement!
- Always keep hands, clothing etc. away from rotating parts!
- Transport equipment - e.g. lighting, warning signs and any protective equipment, must be checked and mounted!
- Working under the implement is forbidden, especially when it is lifted, unless a suitable supporting device is installed.
- Before starting work, get to know all of the equipment and operating elements as well as their functions. It is too late to do so during operation!
- Always perform a visual inspection of the mechanical folding lock before start-up.
- Check the immediate surroundings (watch out for children) before start-up! Ensure that you have an adequate view!
- Before exiting the tractor, activate the brake on the implement, prevent unintentional rolling away, switch off the engine, and remove the ignition key!
- Before each use, check the folding device and its securing elements for proper function and effect.

- Check the implement and the tractor for road and operational safety before every use (e.g. defective parts, connections, hoses, protective equipment, etc.)!
- Never leave the driver's platform while driving!
- Observe the permissible axle load, total weight and transport dimensions!
- Keep the implements clean to reduce the risk of fire!
- Standing between the tractor and the implement is forbidden unless the vehicle is secured against rolling away using the parking brake and/or with wheel chocks!

6.3 MOUNTED IMPLEMENTS

- Only APV implements and accessories may be mounted on the implement.
- Do not stand between the tractor and the implement when actuating the external controls for the three-point mounting!
- When driving on roads, which is only permitted with the implement lifted and with folded side frames, a load-holding valve on the chassis cylinder prevents lowering of the implement and lowering of the folded side frames by means of a mechanical folding lock. Moreover, the roller frame (with hydraulic cylinder) and the tines (mechanically) must be completely lowered.
- The mechanical folding lock prevents unintentional lowering of the side frame during road transport in the event of failure of the tractor hydraulic system.
- When driving on roads with the implement lifted, the operating lever must be locked against lowering!
- For three-point mounting, the mounting categories of the tractor and the implement must match or be adapted!
- Mounting of any sort of accessories onto the implement must be performed according to standards. The maximum permitted mounted weight / total weight of the implement must not be exceeded.
- There is a risk of injury due to crushing and shearing points in the area of the three-point linkage!
- When the implement is in transport position, always ensure that the tractor three-point linkage is sufficiently locked to the sides! If necessary, brace the lower link to prevent oscillation of the implement.
- Before mounting and dismounting implements on the three-point linkage, the operating devices must be moved into the correct position that excludes unintentional lifting or lowering!

6.4 HYDRAULIC SYSTEM

- Due to the risk of injury, use suitable tools when searching for leaks!
- For hydraulic function connections between the tractor and implement, coupling sleeves and coupling connectors should be marked to exclude the possibility of operating errors! If the connections are interchanged, the function will be inverted (e.g. lifting/lowering)! – Danger of accident!
- When connecting hydraulic cylinders and motors, the specified connection of the hydraulic hoses must be observed.
- When connecting the hydraulic hoses to the tractor hydraulic system, make sure that the hydraulic system on the tractor and implement side is unpressurised!
- The hydraulic system is under high pressure during operation! Only disconnect hydraulic hoses once the hydraulic system on the towing vehicle and the implement is depressurised.
- Inspect the hydraulic hose lines at regular intervals and replace in case of damage or wear! The replacement lines must comply with the technical requirements of the implement manufacturer!
- Liquids that escape under high pressure (hydraulic oil) can penetrate the skin and cause severe or fatal injuries! Consult a doctor immediately in case of injury! (Danger of infection, blood poisoning!)
- Before working on the hydraulic system, lower the implement onto the ground, depressurise the system, and switch off the engine!

6.5 MAINTENANCE

- When performing electrical welding work on the tractor and mounted implement, disconnect the cable on the generator and the battery!

- Additional lighting (e.g., flashlight) should be used for repair or maintenance work if necessary.
- It must be replaced immediately before working with the implement in case of damage.
- When performing maintenance on the lifted implement, always ensure safety against lowering through suitable support elements!
- Use suitable tools, protective goggles and cut-resistant gloves when replacing work tools with sharp edges!
- Replacing components that cannot be removed with tools such as a screwdriver or wrench may only be replaced by qualified specialist personnel from an appropriately authorised company or by APV Customer Service.
- The implement must be checked regularly by the operator (before every use) for any fractures and cracks, leaks, chafe marks, loose bolts and connections, vibrations and to ensure it functions correctly.
- The implements should be regularly lubricated and cleaned using water or compressed air. While doing this, personal protective equipment should be worn if necessary.
- Cleaning, maintenance, and servicing work must be performed with the implement lowered, engine switched off, and safeguarded to prevent it from being switched on again.
- The maintenance work itself may only be performed by trained specialist personnel and may never be performed alone. Extreme caution must be taken when changing defective components or tools.
- Spare parts must at least comply with the technical requirements specified by the implement manufacturer! This is ensured with original parts!
- We recommend a gentle cleaning as specified in the maintenance manual. The procedure in in maintenance manual must be observed and protective equipment must be used.
- Maintenance, repair, and cleaning work as well as the elimination of malfunctions should always be performed when the drive is switched off and the motor is at a standstill and the implement is uncoupled from the towing vehicle! Remove the ignition key! Check to ensure that there is no voltage!
- Check the nuts and bolts regularly for tight fit and retighten if necessary!
- Properly dispose of oils, greases, and filters in accordance with national regulations!
- If repair or maintenance work is required on the implement, this work must be identified by a clearly visible information sign "Caution: maintenance work".
- Working under the implement is forbidden!
- Always cut the power supply when working on the electrical system!
- Maintain a safe distance from the implement during possible continued motion due to centrifugal mass. Work can only be performed when it comes to a complete standstill.

6.6 TYRES

- When working on the tyres, it must be ensured that the implement is safely parked and secured against rolling away (wheel chocks).
- The mounting of wheels and tyres requires sufficient knowledge and proper installation tools.
- Check the inflation pressure regularly.
- Regularly check wheel nuts for firm seating and the required torque, and retighten if necessary.
- Repair work on the tyres may only be performed by specialists and with suitable installation tools.

6.6.1 LOAD INDEX AND SPEED INDEX

Tyre dimensions	Load index		Speed index	
	Index	Load capacity	Index	Speed
500-50-17	140	2500 kg	A8	40 km/h
400-60-15.5	145	3150 kg	A8	40 km/h
12.5-80-18	142	2650 kg	A8	40 km/h

6.7 MOUNTED SEEDERS

- When using a seeder, all of the specifications of the implement manufacturer must be observed.
- The seeder can be easily reached with using a step and platform. They must be clean and dry during use.
- The platform kit must only be used as a maintenance walkway.
- An ascent must be established conforming to the standards. This ascent is available from APV.
- When not in use, the steps must be folded up and secured.
- It is strictly forbidden to stand on the platform or its steps while driving.

6.7.1 FILLING THE SEEDER

- When filling the seeder, never stand under a suspended load!
- When driving up to the implement with seed, nobody may be standing on or around the implement.
- The seeder may only be filled using a filling auger or a supply vehicle.
- The platform kit may not be used to fill the seeder or as a storage area for objects or seed.
- During the loading procedure, avoid any contact with the treated seed and wear gloves, a dust mask and safety glasses.

CAUTION!

Misprints, errors and omissions excepted.

6.8 DANGER AREAS

CAUTION!

Travelling danger area

The danger area of the implement travels along with the implement during operation. The danger area includes the area across the entire width of the implement in the direction of travel (see Figure 3). An additional safety distance of 2 m from the implement must be maintained on each side.

- While driving on the field, keep an eye on the entire danger area. Come to a stop if necessary.
- Never climb out of the tractor while driving.
- Never let other people climb on or off while driving.

CAUTION!

Risk of impact and crushing due to moving implement parts

Moving implement parts pose a risk of injuries due to impact or crushing. The danger area includes the area across the entire width of the implement (see Figure 3). Maintain an additional safety distance of 2 m from the implement.

Make sure that there is enough clearance above the implement. The required clearance depends on the width of the moving implement parts and the lifting height.

- Check the danger area before folding and unfolding.
- Keep an eye on the danger area during the folding procedure. Interrupt the folding procedure if necessary.

6.8.1 DANGER AREAS DURING IMPLEMENT OPERATION

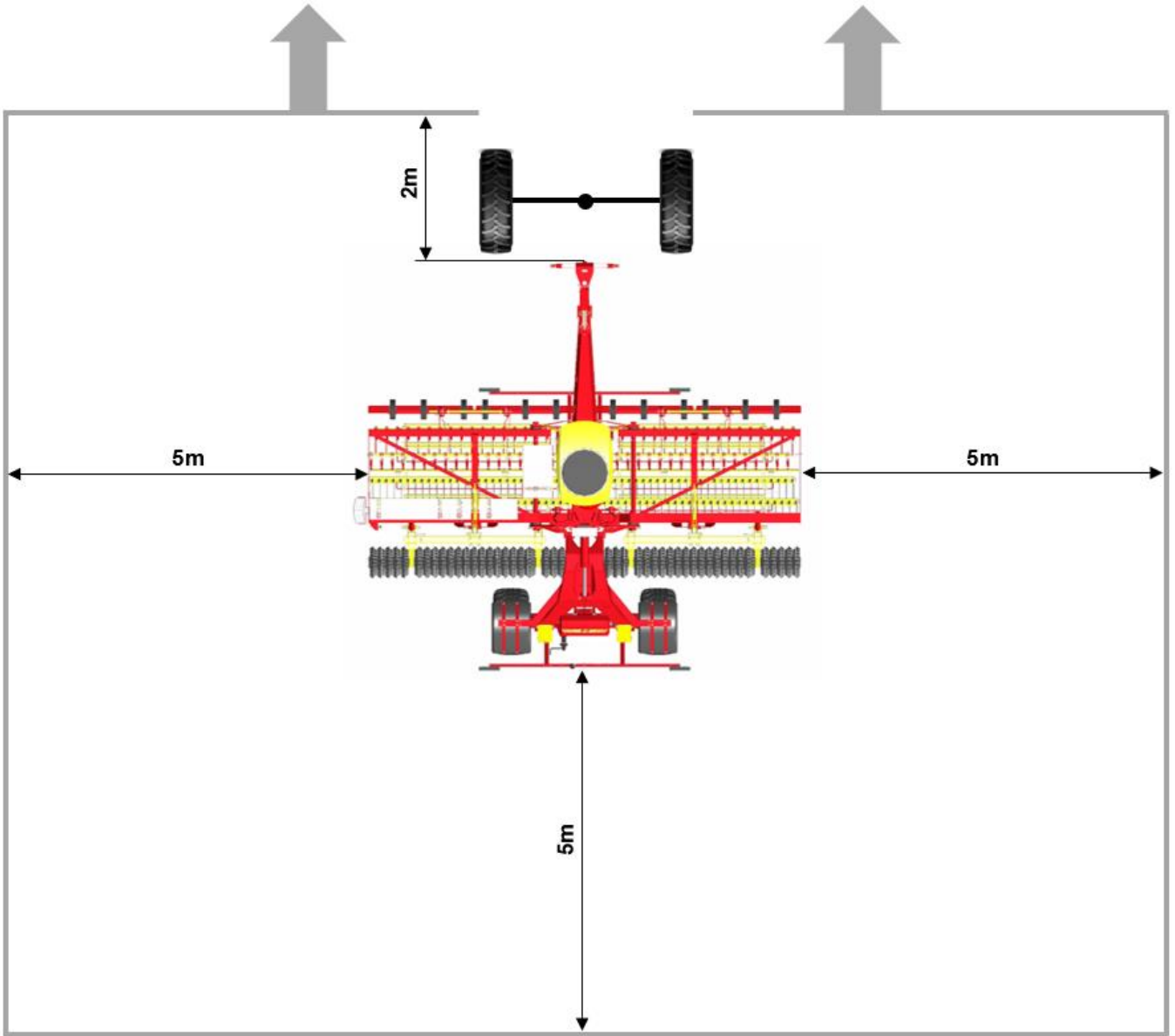

Figure 3

6.8.2 DANGER AREAS WHEN FOLDING AND UNFOLDING

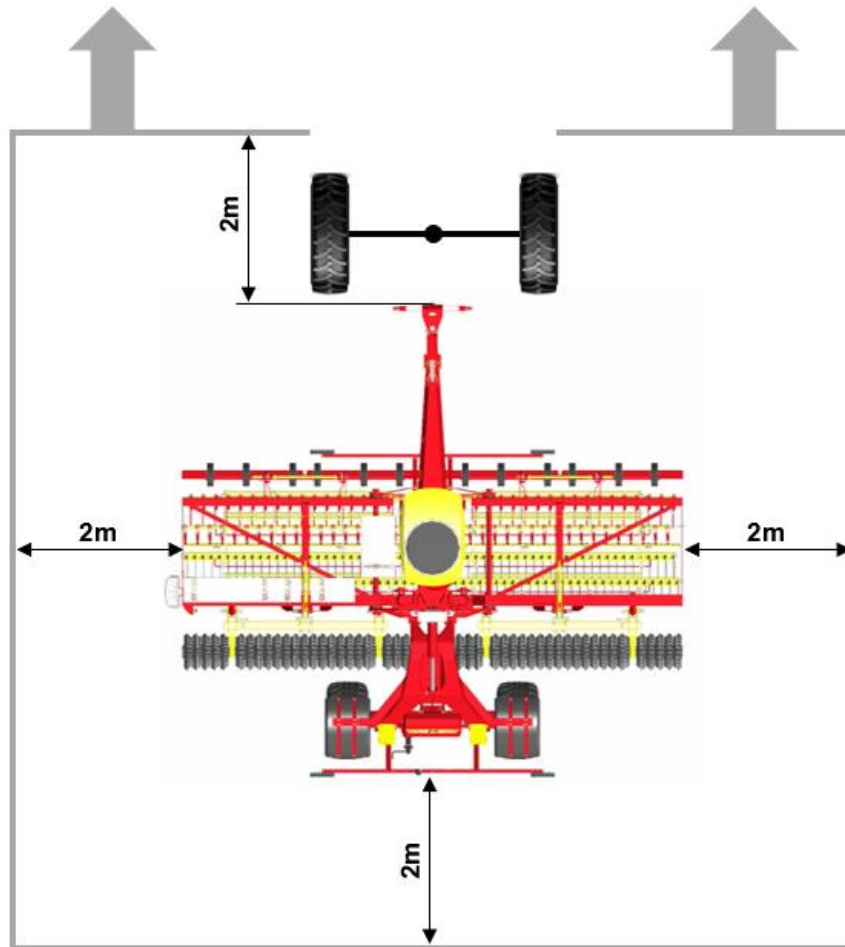

Figure 4

6.9 RESIDUAL HAZARDS

Residual hazards are special hazards when working with the implement, which cannot be eliminated despite safety-compliant design.

Residual hazards are often not obvious and can be a source of possible injuries or health risks.

6.9.1 DANGER FROM MECHANICAL SYSTEMS

There is a risk of accidents due to crushing, cutting and impacts with body parts

- on implement parts that move unexpectedly,
- on implement parts that move due to stored mechanical energy,
- on elastic parts such as springs,
- due to insufficient stability of the implement,
- due to the general shape or installation location of components.

6.9.2 DANGER FROM HYDRAULIC SYSTEMS

There is a risk of injury to body parts, particularly the face, eyes, and unprotected skin areas, due to burning and contamination with hydraulic oil

- due to hot/pressurised hydraulic oil spraying out from leaky connection points or lines,
- due to bursting of pressurised lines or components,
- due to skin contact.
- Wear personal protective equipment!

6.9.3 DANGERS ARISING FROM OPERATION

During operation, there is a risk of injury to body parts, particularly the face, due to stones and clods of soil being flung up.

7 INFORMATION SIGNS / HAZARD LABELS



Pay special attention to the stickers on the implement, as they warn you of specific dangers!







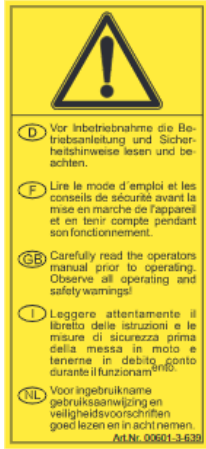

CAUTION!

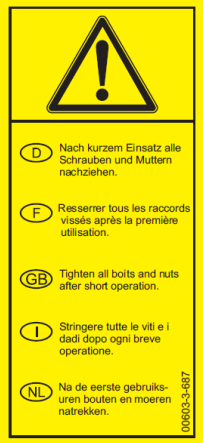
Keep information signs and hazard labels clean

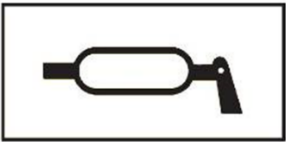

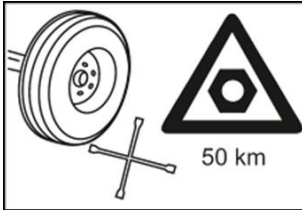
If hazard labels or information signs are becoming or are already detached, they need to be replaced without delay. The respective order numbers can be found under sections 7.1 and 7.2. Contact our Service department for this, see section 4 Service.

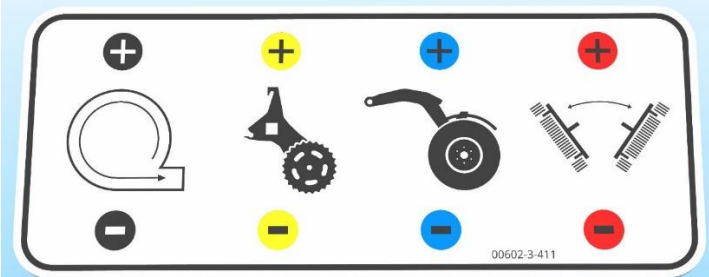

7.1 INFORMATION SIGNS

<p>Information sign</p>			
<p>Order number</p>	<p>00603-3-665</p>	<p>00602-3-293</p>	<p>00601-3-639</p>
<p>Explanation</p>	<p>Read and observe the operating manual before operating the implement!</p>	<p>Do not stand on the implement while driving!</p>	<p>Read and comply with the operating manual and safety instructions before operating the implement.</p>

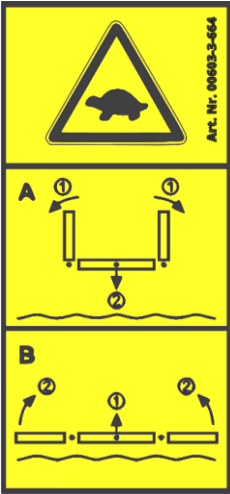
<p>Information sign</p>		 <p>(symbolic representation)</p>	
<p>Order number</p>	<p>00603-3-687</p>	<p>00600-3-138</p>	<p>00600-3-163</p>
<p>Explanation</p>	<p>After a short period of operation, re-tighten all bolts and nuts.</p>	<p>These stickers indicate the tyre inflation pressure.</p>	<p>Labelling of the lubrication points.</p>
<p>Information sign</p>			
<p>Order number</p>	<p>00602-3-119</p>	<p>00600-3-139</p>	<p>00601-3-658</p>
<p>Explanation</p>	<p>Label for the recess for installing the 24-mm bolts.</p>	<p>Retighten the wheel nuts / wheel bolts after 50 hours or 50 km.</p>	<p>Loading hooks. When loading the implement, attach the ropes or chains to these points!</p>
<p>Information sign</p>			
<p>Order number</p>	<p>00602-3-411</p>		<p>00602-3-524</p>
<p>Explanation</p>	<p>Connections for the hydraulic system</p>		<p>Attachment point for the jack. When lifting the implement, place the jack at this point.</p>

7.2 HAZARD LABELS

<p>Information sign</p>			
<p>Order number</p>	<p>00604-3-648</p>	<p>00603-3-664</p>	<p>00602-3-294</p>
<p>Explanation</p>	<p>Caution, crushing area! Never reach into the crushing danger zone as long as the parts can still move!</p>	<p>Always lift the implement slowly off the ground.</p>	<p>Caution, do not climb onto the implement! Risk of rolling over!</p>

<p>Information sign</p>		
<p>Order number</p>	<p>00602-3-764</p>	<p>00602-3-763</p>
<p>Explanation</p>	<p>Danger due to thrown parts; observe the safety distance of 5 m!</p>	<p>Danger due to thrown parts; observe the safety distance of 2 m!</p>

7.3 PLACEMENT OF THE HAZARD LABELS AND OTHER SIGNS

The following figures show the arrangement of the hazard labels and other signs on the implement.

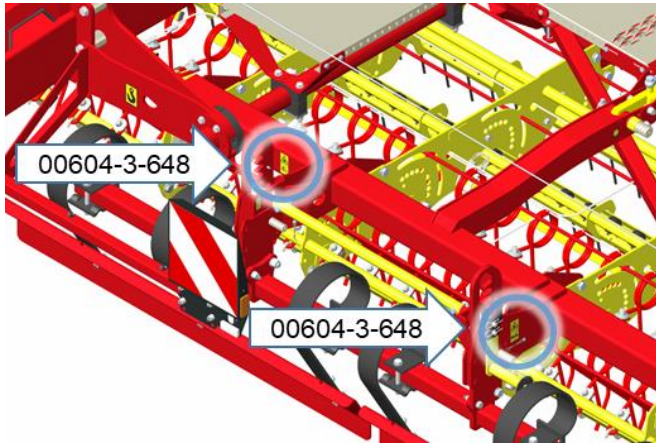

Figure 5

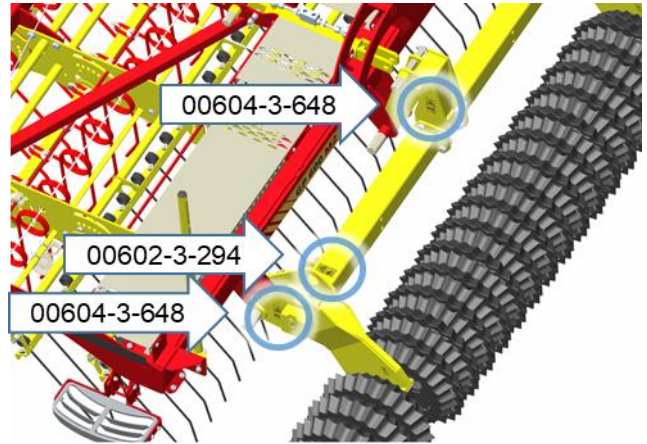

Figure 6



Figure 7



Figure 8

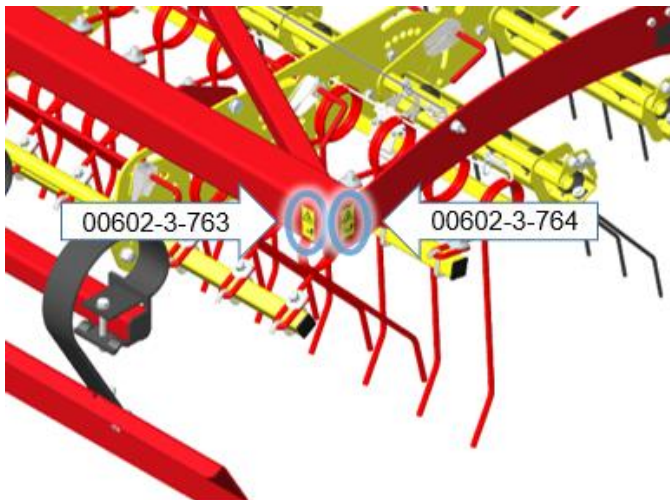

Figure 9

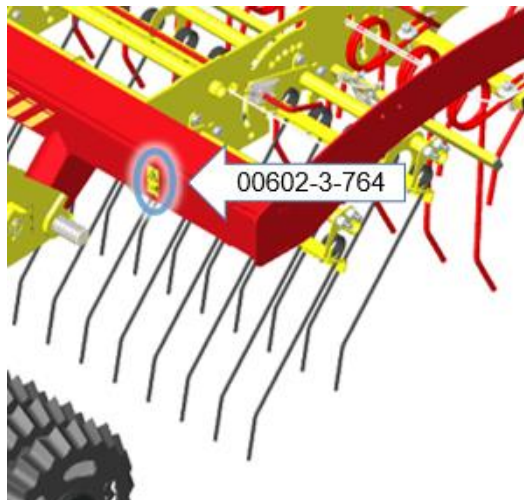

Figure 10

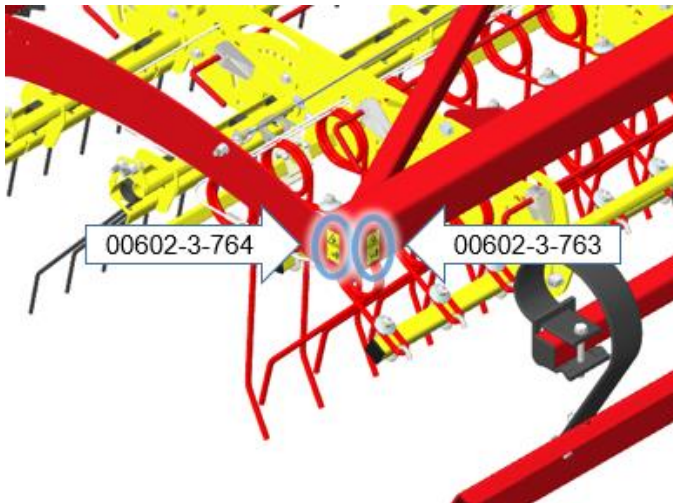

Figure 11

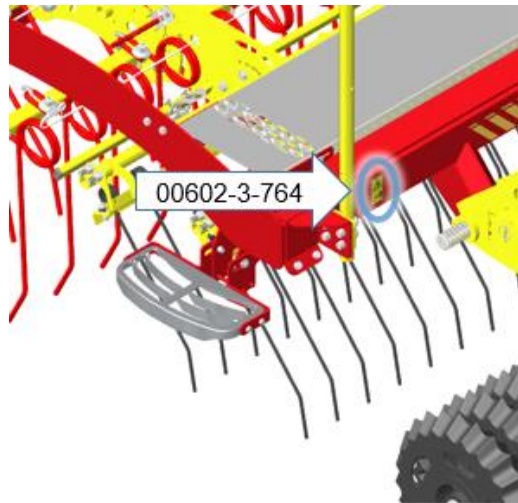

Figure 12

8 OPERATING MANUAL

8.1 LAYOUT AND MODE OF OPERATION

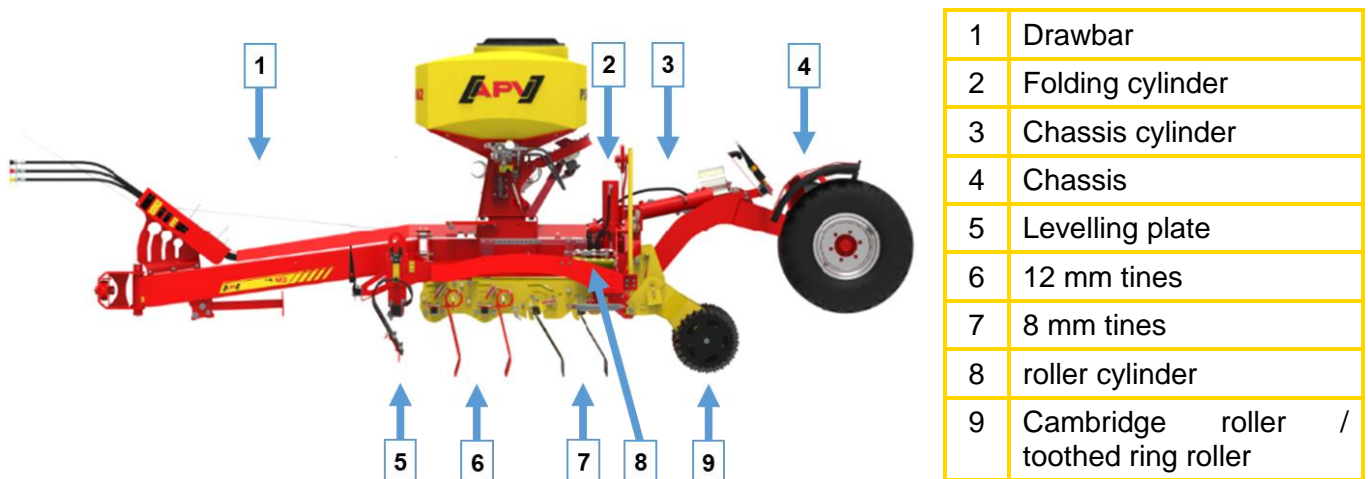

Figure 13

Thanks to its robust and compact design, the Grassland Pro harrow is ideal for new seeding, reseeding, and controlling weeds on grassland.

The spring-mounted levelling plate ensures optimal distribution and levelling of molehills, manure, slurry, and cow pats.

Due to the narrow line spacing of the individual tines, the sward is optimally prepared and the reseeding can germinate rapidly.

With the high contact pressure of the utilised roller, soil closure over the seed is improved and the nutrient supply to the reseeded plants is optimised.

To obtain the best possible rolling results, a forward speed of 8 km/h should not be exceeded. A speed of 6-12 km/h is ideal for grassland.

8.2 MOUNTING AND DISMOUNTING THE IMPLEMENT

8.2.1 GENERAL INFORMATION

- The tractor tyre pressure must be selected as specified by the tractor manufacturer.
- Under difficult operating conditions, additional wheel weights can be useful. Comply with the information provided by the tractor manufacturer.
- The tractor should be equipped with sufficient ballast weight at the front to ensure the steering and braking capacity. At least 20% of the empty vehicle weight is required on the front axle.
- The lifting struts must be adjusted to the same height and locked on the left and on the right.
- The implement must be mounted on the standard lower link.
- Comply with the stickers on the implement and the information provided by the tractor manufacturer.
- Special care must be taken when driving the tractor in reverse. It is forbidden to stand between the tractor and the implement.

8.2.2 PARKING BRAKE

The parking brake is used to secure the implement against rolling away. It must be applied especially during the uncoupling procedure.

To apply the parking brake, the crank (see Figure 14) is turned clockwise – to release it, it is turned counterclockwise.

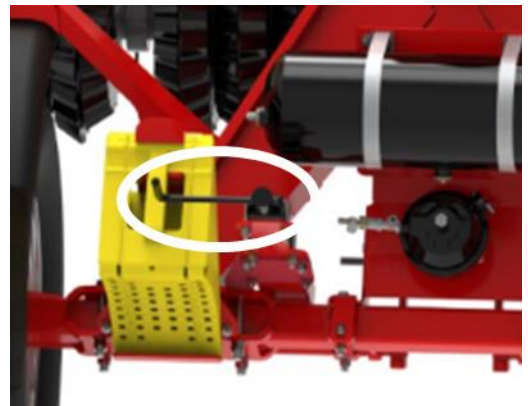

Figure 14: Symbolic image

8.2.3 COUPLING

- The tractor lower links must be locked to prevent lateral oscillation so that they do not start swaying while driving.
- Connect the implement on the lower links of the tractor, which are standardised in accordance with CAT 3N. This means that the balls have a lateral distance of 825 mm. The width of the ball is 45 mm.
- Connect the pneumatic brake system (if present).
If the implement has a pneumatic brake system, the preloaded tractor must be equipped with a pneumatic brake system and it must be coupled for operation. If not, undefined states of the pneumatic brake system can occur that can severely damage the chassis axle.

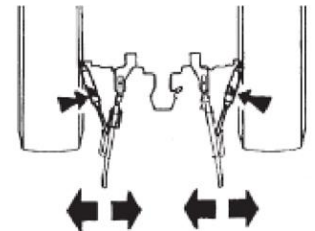

Figure 15

CAUTION!

Comply with the sequence for connecting the pneumatic brake system! First couple the yellow brake line, then the red.

- Remove the wheel chocks and hook them into the holder provided for this purpose.
- Release the parking brake.
- Connect the hydraulic hoses to 3 double-acting control units.

CAUTION!

Only connect the hydraulic hoses once the hydraulic system on the towing vehicle and the implement is depressurised.

- Connect the lighting and electrical cables (if present).
- Test the lighting function.



Figure 16

1	Hydraulic connections for roller (yellow dust caps)
2	Hydraulic connections for chassis (blue dust caps)
3	Hydraulic connections for Pneumatic Seeder and pressureless return (if present)
4	Implement cables for Pneumatic Seeder (if present)
5	Hydraulic connections for folding (red dust caps)
6	Connections for pneumatic brake (if present)
7	Connection for lighting (if present)

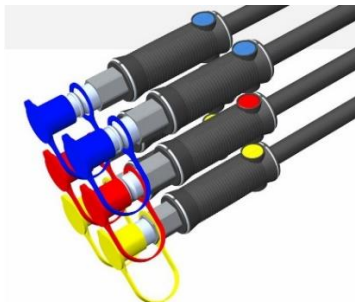

Figure 17

- Check that the hoses and cables hang freely so that they are not damaged in tight curves.
- Fold up the parking support and secure it. To do this, pull out the bolt (Figure 18), fold up the parking support and fix it in place with the bolt (Figure 19).



Figure 18



Figure 19

8.2.4 UNCOUPLING

In a coupled state, the implement must be uncoupled or parked on a firm and level surface so that the support does not sink into the ground and the implement cannot roll away. To uncouple the implement, proceed in the reverse sequence to that described in Point 8.2.2.



CAUTION!

Always secure the implement to prevent it from rolling away.

CAUTION!

Prior to uncoupling, you must check again to ensure that the mechanical folding lock is engaged.

CAUTION!

Comply with the sequence for locking the pneumatic brake system ! First uncouple the red brake line, then the yellow brake line. This is precisely the reverse of the sequence described for coupling the implement.

Ensure that the chassis cylinders and the parking support are adjusted such that the implement rests on the wheels, the roller, and the parking support (see Figure 20).



NOTE!

Place a block of wood 10 – 12 cm in height under the roller shaft. This ensures that the tine beds do not rest on the ground.

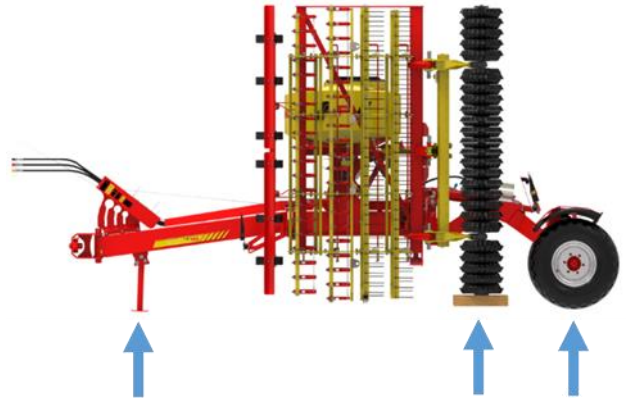

Figure 20

After disconnecting the hydraulic hoses, place the cabling and pressure hoses in the holding device (see Figure 21).



Figure 21

8.3 UNFOLDING FROM TRANSPORT POSITION TO WORKING POSITION

The hydraulic cylinders for depth setting of the roller must be in the maximum possible retracted position. Only unfold the implement under these conditions, otherwise massive collisions or warping can occur between the two roller segments.

The amount of oil on the control units of the coupled tractor must be reduced accordingly, so that the entire folding procedure runs slowly (at least 12 seconds) and is gentle on the implement.

After complete unfolding, the control unit on the coupled tractor must be put in float position to ensure the desired ground adaptation of the implement.

If the implement is unfolded or operated differently than described in these instructions, the manufacturer is no longer liable.

8.4 FOLDING FROM WORKING POSITION INTO TRANSPORT POSITION

The hydraulic cylinders for depth setting of the roller must be in the maximum possible retracted position. When using the 410 mm toothed ring roller, the total length of the clips that are used on the roller cylinders must not exceed 100 mm. If a greater length of clips should be used, they must be removed before road transport to maintain the road transport width of < 3.0 m.

When using a roller with a larger diameter, the length of the installed clips must be reduced accordingly to maintain the road transport width of < 3.0 m.

The control unit on the coupled tractor for adjusting the roller hydraulic cylinders must be appropriately secured during road travel, so that the road transport width cannot be inadvertently misadjusted, i.e. increased.

8.5 WORKING POSITION AND SETTING THE WORKING DEPTH

8.5.1 DEPTH SETTING / DRAWBAR ADJUSTMENT

The working depth of the implement is adjusted via the roller position and the height of the lower links:

1. Add or remove hydroclips on the roller cylinder, depending on how aggressively the soil should be tilled.

Only adjust the working depth via the roller cylinders in lifted and folded transport position because the clip carriers on the implement cannot be reached without danger.

After the newly selected number of clips have been installed on the roller cylinders, the implement unfolded into working position again and the newly selected working depth must be tested. This procedure must be repeated until the right working depth has been determined.



Figure 22

Special care must be taken when removing the clips so that the aluminium shells do not fall out of the spring clamps, because they cannot be separately secured.

To be able to install the clips, the roller cylinders must be slightly extended. To prevent the roller cylinders from moving too fast, the flow rates on the control units of the coupled tractor must be set to minimum oil quantities.

After the desired number and thickness of hydroclips have been hooked in or removed, the roller cylinders must again be retracted to the stop.

CAUTION!

For all cylinders, the same number of hydroclips in the appropriate thickness must be installed.

2. The lower link must be positioned such that the frame of the implement is parallel to the field. With the position of the lower link, the working depth can also be adjusted as required.

TIP!

The working depth must be checked after driving for 10 m and re-adjusted if necessary. For larger work areas, the working depth of the tines must be checked from time to time.

8.5.2 ADJUSTING THE SERIES OF HOLES

In addition to depth setting, the aggressiveness of each individual tine row can also be changed individually. This makes it possible to compensate for the different levels of wear of the individual tines.

For series of holes adjustment, the bolts for the tine sections are inserted either in a higher / more forward or lower / more rearward hole (see Figure 23).

The front two rows of tines (12 mm tines/red) tear open the sward, the rear tine rows (8 mm tines/black) produce an optimal seedbed for the new grasses.

If the front row of tines (12 mm/red) should work more aggressively (e.g. in hard soil conditions), you must place the bolt in one of the rear holes. For soft soils or wet conditions, it is possible to only have the rear tines (8 mm tines/black) working actively, by moving the front tine rows (12 mm tines/red) upward (front-most hole).

If you want to adjust the work pattern of the rear 8 mm tines (black), select one of the four levels. At an optimal forward speed, the tines make an elliptical motion. The steeper the position of the tines, the smaller the motion. The flatter the position of the tines, the larger the motion. If the sward is dense and intense tillage is required, the tines should be positioned more steeply (see Figure 23).

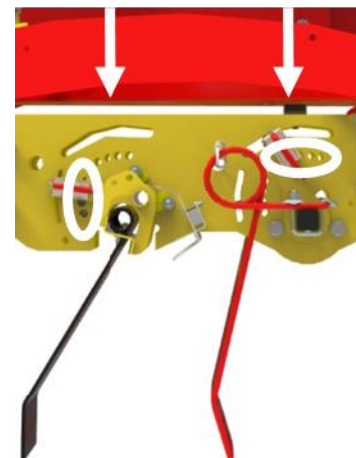

Figure 23

8.6 USING INDIVIDUAL TOOLS

It is possible to use individual tools on the implement (levelling plate, harrow and roller) separately or in any combination.

For example, the roller can be used alone by completely extending the roller cylinder. In this way, you can also use the implement on field crops for rolling after seeding.

If you only want to level and roll, the roller and the levelling plate are moved down and the tine rows are turned up, so that they are lifted off of the ground.

If you only want to use the implement for weeding, feeler wheels are installed instead of the roller, the levelling plate is moved up and the implement is lowered onto the feeler wheels.

8.7 LEVELLING PLATE

The levelling plate eliminates molehills after the winter and serves to roughly level the grassland. The height should be adjusted so that it runs along the sward just above the ground. It should not scratch into the sod. However, if the sod is very uneven, allowing the levelling board to slightly penetrate into the soil can improve the levelling effect on the long term.

To adjust the working height, remove the 2 locking pins, crank the levelling plate to the desired height and fix it in place at the new height with the locking pins (Figure 24).

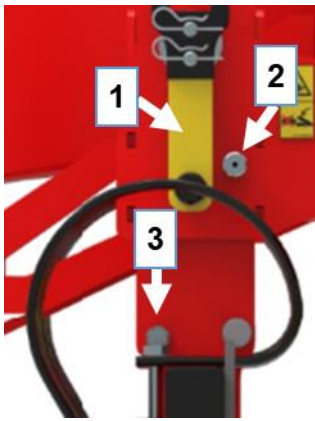

Figure 24



Figure 25

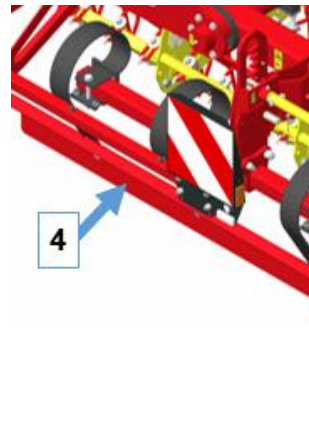

Figure 26

1	Crank
2	Locking pin
3	Shear bolt
4	Levelling plate

CAUTION!

Only operate the crank with one hand; two-hand operation poses a considerable risk of injury (hand or finger injuries). The crank has a slip safeguard for better handling and transmission of force.

Note that crank operation requires very high actuation forces to adjust the levelling plate. If the user or operator is unsure as to whether the required actuation forces can be applied, the levelling plates must be secured with blocks placed underneath them.

TIP!

Remove the bolt on the right first, and then the left bolt, so that you can lift the levelling plate more easily with the crank.

The levelling plate has a shear-off safety to prevent damage to the frame due to excessive loads on the levelling plate.

NOTE!

The implement accessories include 3 sets of shear bolts. When these have been used, attention must be paid to the quality of the replacement bolts. Only M12x60 bolts with a quality of 4.6 may be used.

The tightening torque of 10 Nm for the M12 bolts may not be exceeded. If the M16 bolts behind have become loose, a maximum tightening torque of 15 Nm must be observed (Figure 24).

8.8 COUPLING AND UNCOUPLING THE ROLLER

To couple the roller, proceed as follows:

1. Unfold the implement on paved and level ground.
 2. Completely lift the implement using the chassis cylinder, and lower the lower links as far as possible.
 3. Completely retract the roller cylinder.
 4. Install the parking support for the roller frame, it is located on the side of the roller frame (see Figure 27).
 5. Remove the locking pins on the roller (Figure 28).
 6. Completely extend the roller cylinder.
 7. Move the tine rows into the position shown in Figure 29.
 8. Carefully lower the implement completely and pull up the chassis as far as it goes. Now the implement is only still carried by the tine beds.
 9. The roller is now uncoupled and can be transported away to the rear.
- If you want to couple the roller back onto the implement, proceed in the reverse sequence.



NOTE!

It must be noted that by removing the roller, uniform depth control can no longer be ensured for the harrow units. For this reason, feeler wheels must always be installed when the rollers are removed.



CAUTION!

The rollers may only be installed or removed when the feeler wheel mounting kit is used (see Point 18.9).

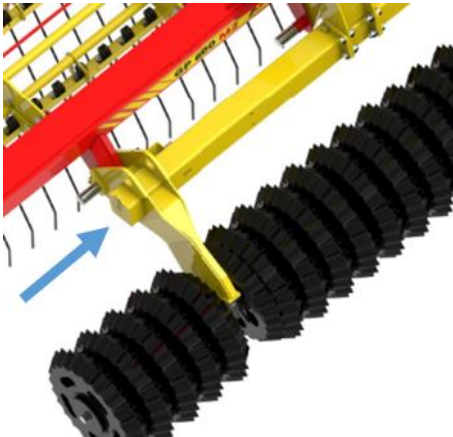

Figure 27



Figure 28

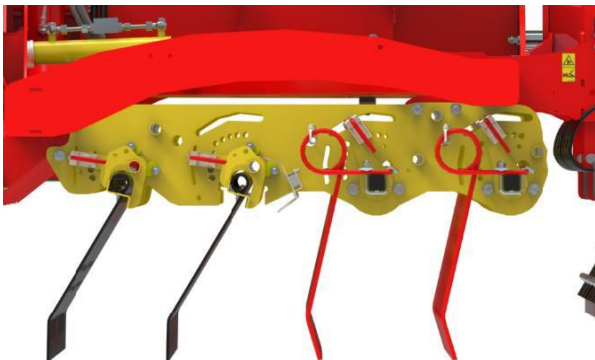

Figure 29

8.9 FOLDING LOCK

The implement has a mechanical folding lock with locking hooks that engage on the side frames. This becomes effective, as soon as the side frames are completely folded.

The mechanical folding lock prevents unintentional unfolding through accidental activation of the control unit or line break.



Figure 30

CAUTION!

For every folding process of the side frames, the operator must visually inspect the folding lock. Road transport of the implement is only permitted if the folding lock is engaged.

TIP!

For easier release of the folding lock, briefly apply pressure to the folding cylinder. This fully extends the folding cylinder and the side frame is completely lifted again.

8.10 TURNING ON THE HEADLAND

8.10.1 TURNING WITH ROLLER

When turning on the headland, first the lower links are lifted, then the roller is pressed downward so that the implement runs on the rollers. Lifting the lower links is required so that adequate ground clearance is ensured underneath the tine bed and the tines are not bent laterally.

CAUTION!

We recommend that you only use the bearing control unit of the 3-point power lift on the tractor to avoid uncontrolled depth changes on the lower links.

8.10.2 TURNING WITH CHASSIS

The implement is lifted via the chassis, in order to subsequently turn. Here, we also recommend lifting the lower links.

NOTE!

If the hydraulic sensor for the mounted seeder is installed in the roller cylinder, the sensor will not be active when turning on the chassis. To remedy this situation,

- a) a qualified specialist can install the hydraulic sensor in the chassis cylinder.
- b) when turning, a brief, manual pressure pulse can be given to the roller cylinders, so that the seeding shaft is switched off. In this regard, note that after turning another pressure pulse must be given so that the seeding process can be resumed.

8.11 LOADING AND UNLOADING ON A LOW-LOADER

Comply with the following instructions if you want to transport the implement with a low-loader:

- The implement must be folded and the chassis must be lowered (see Figure 31).
- During the loading and unloading procedure, the implement must be lifted as far as possible to achieve the greatest possible ground clearance.
- Set down the implement longitudinally on the low-loader (see Figure 31).
- The lashing points are located on the
 - Centre frame (2 lashing points)
 - Drawbar (1 lashing point)
 - Side frames (1 lashing point per frame)
 - Roller frames (1 lashing point per frame).

Each lashing point is marked with the info sign "Load hook" (see Point 7.1).

- Firmly engage the parking brake (if present).
- Lash the wheels.

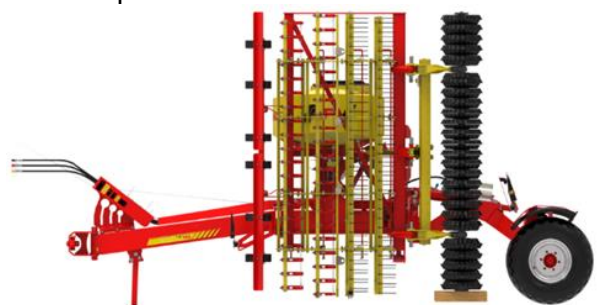

Figure 31

9 ASSISTANCE IN CASE OF MALFUNCTIONS

9.1 PROCEDURE IN CASE OF MALFUNCTIONS OR ERRORS

If errors or untypical behaviour occur during start-up of the implement, please contact our Service Centre, see section 4 Service.

10 MAINTENANCE AND CARE

To maintain the implement in good condition even after a long service life, the following instructions must be observed:

10.1 GENERAL MAINTENANCE INSTRUCTIONS

- In Point 6.5, you will find some basic safety regulations for maintenance work.
- When replacing the hydraulic hose lines, original spare parts must be used that comply with the technical requirements of the implement manufacturer.
- The paint can be damaged by cleaning with excessive pressure.
- The manufacturer is not liable for any unauthorised modifications and the use of components and auxiliary parts.
- Put down the implement in a way that the tines are not needlessly strained. (Roller all the way down, use the parking supports at the front.)
- Park the implement protected from weather conditions.
- Do not use a high pressure cleaner to clean bearing points and hydraulic parts.
- Original parts and accessories are designed especially for the machines or implements.
- Clean the implement with water or compressed air, however ensure that you do not use excessive pressure. The paint can be damaged by cleaning with excessive pressure. Particularly when using high pressure cleaners, the pressure must not exceed 120 bar; cleaning water temperature must not exceed 30 °C. Do not use dirt blasters or mud blasters. The minimum distance of the spray lance to the surface of the implement is 50 cm.
- During the winter, the implement should be protected against corrosion with an environmentally-friendly product.
- Please note that original spare parts and original accessories not supplied by us have also not been tested and approved by us. The installation or use of such products can therefore possibly negatively change or impede the constructional properties of your implement. The manufacturer rules out any liability for damages resulting from the use of non-original parts and accessories. Liability for damage resulting from the use of such parts is likewise excluded.

10.2 INSTRUCTIONS FOR REGULAR MAINTENANCE

- All bolted connections should be re-tightened at the latest after 3 operating hours and again after 20 hours, and then checked regularly. Loose bolts can cause significant consequential damage, which is not covered by the warranty.
- The platform kit and its steps must be visually inspected on a regular basis.
- The hydraulic system must be inspected at least once a year by specialist personnel.
- Regularly lubricate the lubrication points on the folding points, joints, and bearings (see Point 10.5) (with multipurpose grease approx. every 10 operating hours).
- Hydraulic hose lines must be replaced at the latest 6 years after their manufacturing date. The manufacturing date of the hydraulic hose lines is specified on the fittings.
- After cleaning, lubricate all of the grease points and distribute the grease evenly in the bearing points (e.g. perform a short test run).

- After the first 10 operating hours and subsequently every 50 operating hours, the hydraulic units, hoses and couplings as well as tube lines must be checked for leaks and the bolted connections must be tightened if necessary.
- Before every operation, check the hydraulic hose lines for wear, damage and ageing. Damaged or faulty parts must be immediately replaced.
- The wheel nuts must be checked and retightened every 50 km. The tightening torque for the wheel nuts can be found in the following table.
- Check the tyre pressure before each use. The tyre pressures for the respective tyre dimensions are specified in the table below:

Tyre dimensions	Tyre pressure	Tightening torque for the wheel nuts
500-50-17	2.2 bar	320 Nm
400-60-15.5	3.4 bar	320 Nm
12.5-80-18	4.0 bar	320 Nm

10.3 CHANGING THE TINES

To replace broken or worn tines, unscrew the nuts and take off the tines.

- The new 12 mm tine, as shown in Figure 32, is hooked into the hooks and the nuts are firmly retightened. Pay attention to the proper line spacing! The tines in the rear row cut the distance of the front tines in half.
- The new 8 mm tine, as shown in Figure 33, is fixed in place with a bolt. Ensure that the bolt rests firmly on the tine and that all tines form a straight line. There must be one washer above and below the tine respectively, and one washer below the mount.
- Always use new lock nuts.

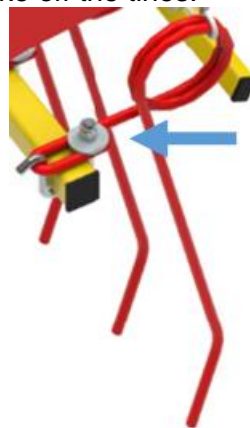

Figure 32



Figure 33

10.4 TINE SAFETY

As standard, the GP series is equipped with a tine safety that prevent loss of the 12 mm tines by means of a rope. It protects the tines so that they do not get lost on the pasture or on the field. This also prevents damage to other implements, e.g. the mower or the baler.

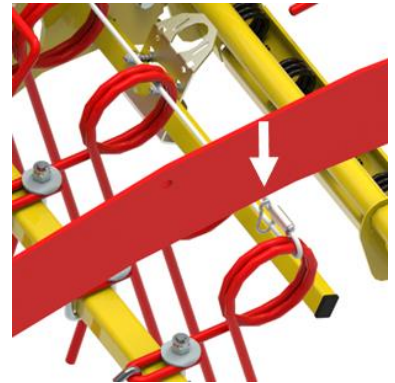

Figure 34

10.5 LUBRICATION SCHEDULE

The brake linkage on the axle must be lubricated as specified by the axle manufacturer. Note that excessive lubrication can cause grease to get into the brake drums.

The following lubrication points on the folding points, joints, and bearings must be lubricated regularly with multipurpose grease (approx. every 10 operating hours):

Quantity	Position
1	Bearing on the lower link rod, lateral slope compensation (Figure 35)
1	Bolt, pivot point when driving in curves (Figure 35)
4	Bearing of the side frames (2 lubrication points per frame, Figure 36)
6	Bolt and pivot point of the folding cylinder (3 lubrication points per folding cylinder; Figure 37 no. 1)
2	Bearing between chassis and frame (1 lubrication point per frame Figure 37 no. 2)
2	Bolt on the chassis cylinder (Figure 38)
4	Roller bearing (2 lubrication points per frame; Figure 39)
4	Levelling plate bearing (2 lubrication points per levelling plate; Figure 40)
2	Brake linkage on the axle (1 lubrication point per tyre; Figure 41)
1	Tightening spindle (if present; Figure 42)



NOTE!

Each bearing must be offloaded beforehand, so that the lubricating grease can be distributed uniformly in the bearing point.



Figure 35

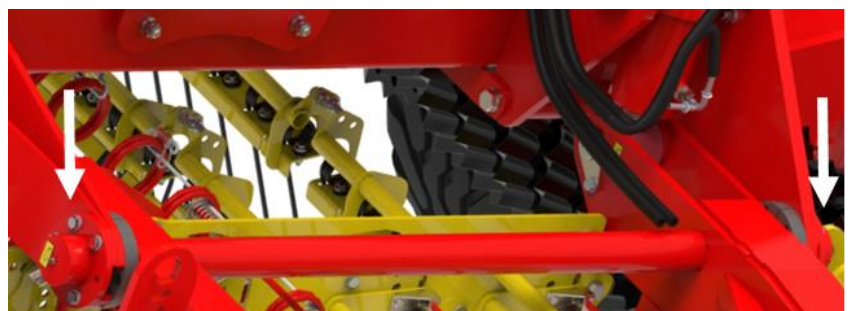

Figure 36

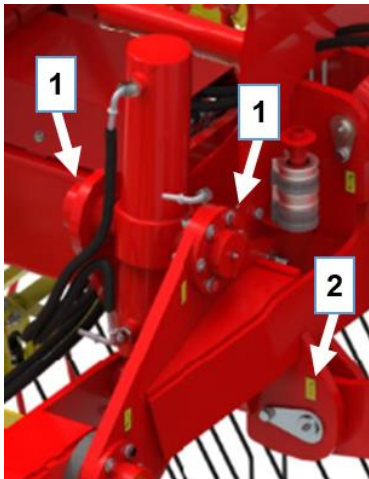

Figure 37

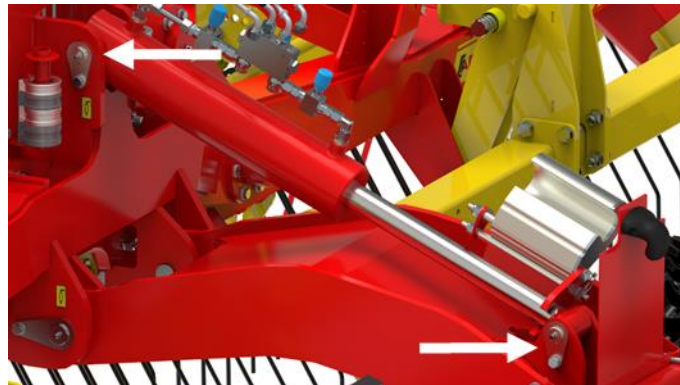

Figure 38

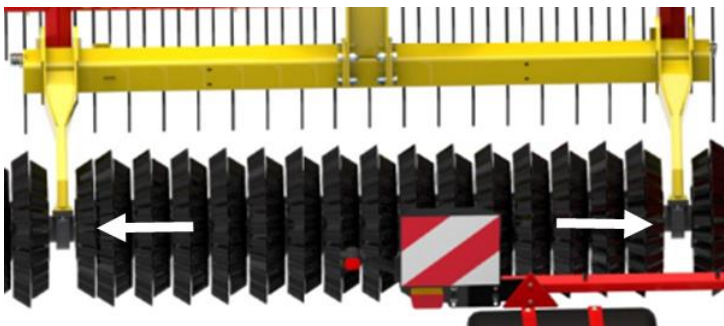

Figure 39



Figure 40

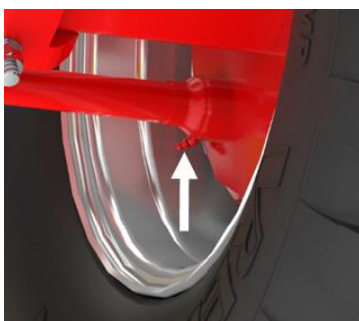

Figure 41



Figure 42

10.6 REPAIRS AND SERVICE

In case of failure or damage to the implement, please contact the manufacturer. The contact data can be found in chapter 3.

11 INFORMATION ON NATURE CONSERVATION AND ENVIRONMENTAL PROTECTION

Energy-efficient use

The tines of the implement should not penetrate into the field deeper than necessary. By doing so, the towing vehicle is not unnecessarily strained and fuel can be saved.

Recyclable raw materials during disposal

Many parts of the implement are made of steel or spring steel (such as the centre frame, side frames, etc.) and can be removed and recycled by a waste disposal company.

12 TECHNICAL DATA

Type designation	GP 600 M2		
Working width	6 m		
Transport dimensions (folded) in m (HxWxD)	3.50 x 2.99 x 5.75		
Weight (toothed ring roller 410 mm and PS 500 H)	4,800 kg		
Tyres (transport wheels)	500/50-17"		
Tine rows	2 rows with 12 mm tines (red) 2 rows with 8 mm tines (black)	3 rows with 12 mm tines (red)	4 rows with 8 mm tines (black)
Line spacing	75 mm (12 mm tines/red), 50 mm (8 mm tines/black)	68 mm	50 mm
Number of tines	80 tines (12 mm tines/red) 120 tines (8 mm tines/black)	88 tines	120 tines
Brakes	Dual-circuit pneumatic brake		
Mounting category	CAT 3N		
Tractor performance	88 kW / 120 HP		
Leading tools	Levelling is spring-suspended and height-adjustable		
Working tools	Round spring tines		
Trailing elements	Toothed ring roller d = 410 mm Cambridge roller d = 530 mm		

13 POSSIBLE COMBINATIONS WITH A PNEUMATIC SEEDER

	Dimensions HxWxD [cm]		GP weight [kg]	PS200 H	PS300 H	PS500 H	PS800 H
	Delivery Without PS	Road transport Without and with PS 500	Without PS	Dimension HxWxD [cm]			
				100x70x110	110x77x150	117x80x125	127x105x170
GP 600 toothed ring roller 410 mm	350 x 299 x 575		~ 4700	Can be combined with PS mounting kit			
GP 600 Cambridge roller 530 mm	350 x 299 x 575		~ 4750	Can be combined with PS mounting kit			

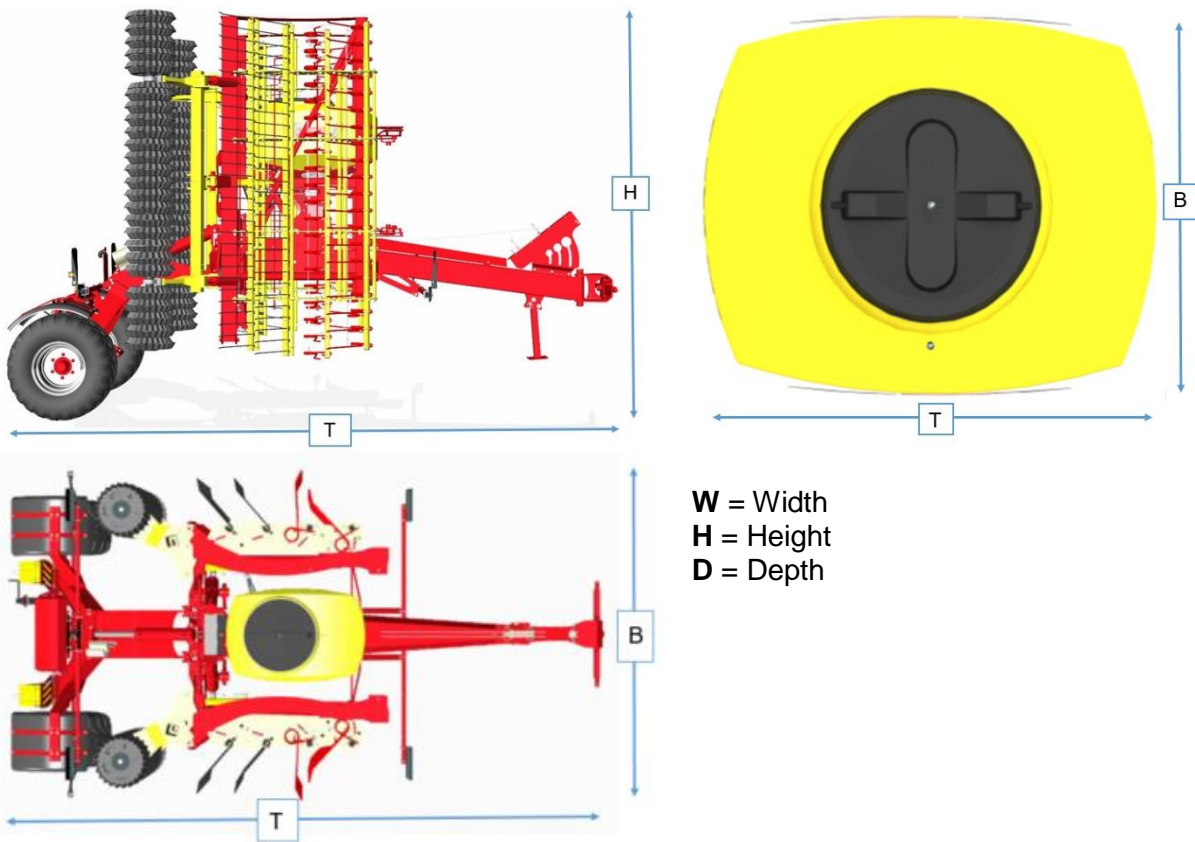

14 ROAD TRANSPORT

14.1 TRANSPORT ON PUBLIC ROADS (GENERAL INFORMATION)

- Comply with the road traffic regulations of your country's legislation.
- The axle load and the total weight of the towing vehicle may not be exceeded.
- The mounted implement must be identified with country-specific warning signs or stickers with red and white slanted lines (according to DIN, ÖNORM or the respective country-specific STANDARDS).
- Any part posing a traffic hazard or dangerous parts (e.g. tines) must be covered and additionally identified with warning signs or stickers.
- Warning signs or stickers should be visible at a height of max. 150 cm above the road when driving.

- 
- Lighting equipment of the towing vehicle may not be hidden by the implement; otherwise, they must be installed on the mounted implement.
 - The steering capacity of the tractor must not be impeded or reduced by the mounted implement!
 - To achieve transport position, i.e. the necessary width for road transport, both the side parts and the rollers must be completely folded. In doing so, particularly ensure that you have not installed too many clips on the hydraulic cylinders for the roller adjustment; if too many clips are installed, the transport width of < 3.0 m cannot be maintained.
 - Make sure that the folding lock is engaged!
 - Also check that none of the cotter pins or similar items were lost in operation.
 - Only relieve the hydraulic hoses at home by putting the tractor control unit into float position.
 - The holder for the warning signs is mounted on the centre frame and the chassis.
 - For road travel after field operation, clean off any soiling (soil, grass, etc.) on the implement.
 - Before road transport, check that the hydraulic and brake system are properly connected and also that the parking brake is released before starting to drive. Check the braking effect before departing.
 - Check for proper function of the lighting as well as good visibility of the warning signs with lighting (accessories).
 - Secure the side parts of the implement in transport position to prevent dangerous load shifting by using the folding lock provided for this purpose.
 - Adapt your driving speed to the current conditions.
 - After completely folding and locking the two securing hooks in place, the hydraulic lines must be briefly relieved so that the side parts are properly resting in the securing hooks. After briefly relieving the control unit, it must be locked to ensure two levels of safety.

15 LIGHTING CIRCUIT DIAGRAM

Legend:

R	Right
1	12 V plug, 7-pin
2	Rear light, right
2.1	Turn signal
2.2	Rear light
2.3	Brake light
L	Left
3	Rear light, left
3.1	Brake light
3.2	Rear light
3.3	Turn signal

Plug and cable assignment

No	Desi g.	Colour	Function
1	L	Yellow	Turn signal, left
2	54g	---	---
3	31	White	Earth
4	R	Green	Turn signal, right
5	58R	Brown	Rear light, right
6	54	Red	Brake light
7	58L	Black	Rear light, left

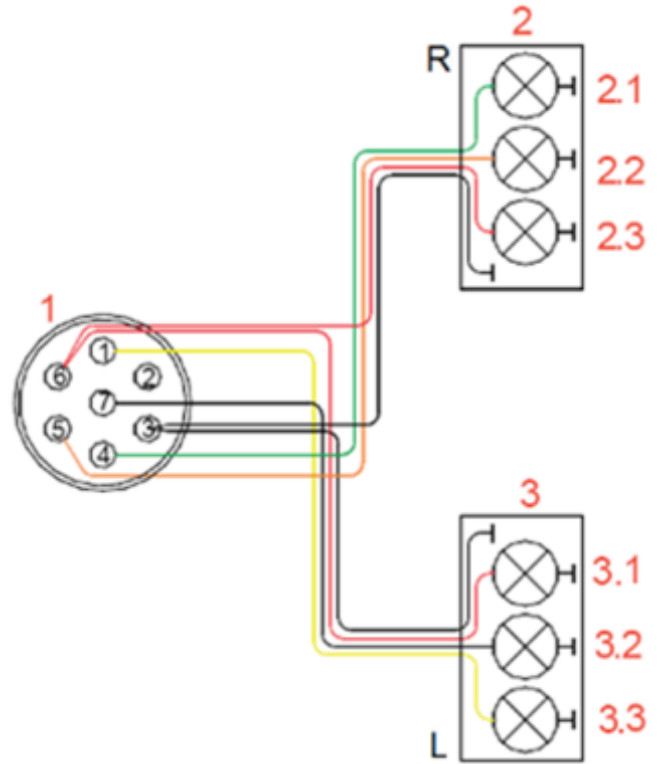

Figure 43

16 DECOMMISSIONING, STORAGE AND DISPOSAL

16.1 DECOMMISSIONING THE IMPLEMENT

To ensure that the implement remains fully functional, even if it is out of operation for longer periods of time, it is important to take precautions for storage: To do so, observe Point 16.2.

16.2 STORAGE OF THE IMPLEMENT

- The implement must be stored in a dry place protected from weather conditions to ensure that it remains functional even if it is stored for a longer period of time.
- Uncouple the implement as specified in Point 8.2.
- Secure the implement against unintentional rolling away.
- Nothing may be deposited or stored on the implement.
- The implement must always be parked and stored in a secure area, to prevent unauthorised operation.



16.3 DISPOSAL

The implement and the required work materials (operating materials such as hydraulic oil) must be disposed of according to the local disposal regulations for machines.

17 CROP CULTIVATION TIPS FOR USE OF THE GRASSLAND PRO HARROW

Seedbed preparation is always required before reseeding. This procedure is optimally accomplished with the Grassland Pro Harrow with 4 rows of tines. Together with the reconsolidation by a roller, five working procedures are accomplished in one field pass.

With its thorough and effective mode of operation, the implement can be optimally integrated into your overall cultivation concept.

The goal of your concept will be to improve yields and to increase the valuable grasses.

Other effects of the implement, such as

- Soil aeration,
- Regulation of the water balance,
- Incorporation of the seed,
- Reconsolidation,
- Pressing down the seed and therefore
- Promoting tillering

make a significant contribution to the formation of good crops.

The success of weed control without chemicals and high yields, however, depend very strongly on you, as you will be required to closely observe the processes in your soil.

Reseeding of grassland is theoretically possible during the entire frost- and snow-free period. Gaps in the crops should already be reseeded in the spring to prevent weed competition. As a matter of principle, you should reseed more frequently and therefore work less aggressively and reduce the seed quantity.

Reseeding can be performed in the spring as soon as the soil has warmed up a little. The soil must have good trafficability, i.e. the seed should not be "smeared in" in any case.

Reseeding in the spring has the advantage that the spring humidity and the disturbed soil can be used as a seedbed. However, despite the good start, the grass can dry out during a summer drought, and the pressure of the old sod is greater in the spring due to the stronger growth spurt.

With the Grassland Pro Harrow, we counteract this disadvantage with a roller that presses down the seed and therefore improves soil contact. This allows the seed to germinate more rapidly and the risk of desiccation is reduced.

The optimal strength and depth setting, forward speed and the adjustment of the tines and seeding rate must be set with your understanding of the correlations between the soil properties and weather conditions, which can vary greatly in different regions.

18 ACCESSORIES

18.1 EQUIPMENT KIT FOR OPERATION ON PUBLIC TRAFFIC AREAS

This kit is required to comply with all requirements for operation on public traffic areas.

The kit contains the following components:

- Dual-circuit pneumatic brake system
- Wheel chocks
- Tine sections cover
- Lighting with warning signs
- Mudguard
- Anti-theft device

The listed components are described in more detail in the following sub-points.

Order number:

06028-2-282

18.1.1 COMPRESSED AIR SYSTEM

The implement is equipped with a dual-circuit pneumatic brake system. The supply reservoir has a volume of 20 litres. From the tractor, the two compressed air lines (supply and brake line) lead to the brake valve.

From the brake valve, one line leads to the supply reservoir, the other to the wheel brake cylinders.

The compressed air system is also available separately, the following order number can be used for this:

Order number:

06028-2-249

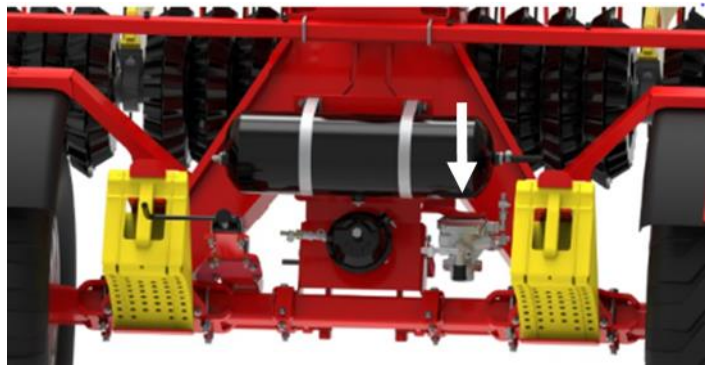

Figure 44: Symbolic image

CAUTION!

Because the brakes are immediately release when the compressed air reservoir is filled, it is important to comply with the connection sequence: first couple the yellow brake line, then couple the red brake line!



TIP!

If one compressed air line on the implement should be defective, the implement can still be moved by manually triggering the pressure accumulator on the trailer brake valve (see Figure 45).



Figure 45

Note that with a vented trailer brake valve, the service brake is not active, therefore the forward speed imposed by the country-specific regulations for unbraked, towed agricultural machinery must be complied with.

18.1.1.1 DRAINING

A drain valve is provided on the underside of the reservoir. It must be actuated weekly throughout the year and daily in the winter.

TIP!

Drain the air reservoir daily. Using a wire, move the bolt in a sideward direction.

If the drainage valve should become too dirty, screw it out of the pressure reservoir and clean it thoroughly.



Figure 46

CAUTION!
The reservoir is under pressure!

18.1.1.2 READJUSTING THE BRAKE SYSTEM

In the middle of the axle, there is a diaphragm cylinder. It can be readjusted using a threaded rod if necessary. The path from actuation of the cylinder to active braking may only account for max. one third (ca. 25 mm) of the total stroke.

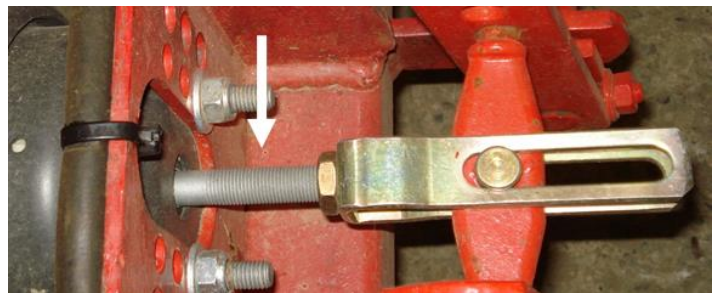

Figure 47

18.1.1.3 MEASURING THE COMPRESSED AIR

It is possible to measure the compressed air at two locations using a pressure gauge. One location is the supply reservoir and the other is beside the diaphragm cylinder. The pressure in the reservoir must be at least 6.5 bar.



Figure 48



Figure 49

18.1.1.4 PNEUMATIC BRAKE SYSTEM DIAGRAM

The diagram of the dual-circuit pneumatic brake system is as follows:

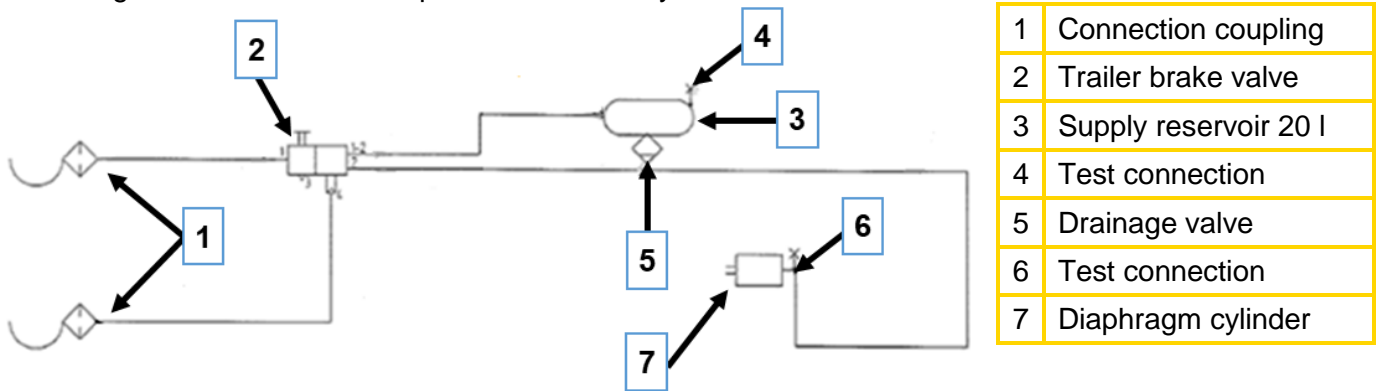

Figure 50

18.1.2 WHEEL CHOCKS

The wheel chocks prevent the implement from rolling away. The wheel chocks are also available separately, the following order number can be used for this:

Order number:
06028-2-251

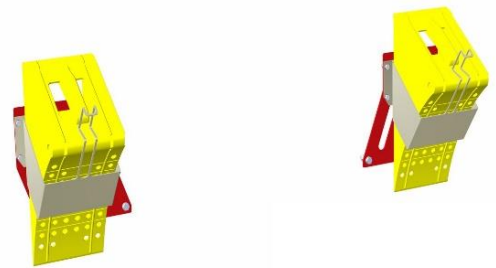

Figure 51

18.1.3 TINE SECTIONS COVER

With this protection, the bottom tine rows of the outer tine sections are covered. During operation, the cover can be conveniently stowed.

The cover is also available separately, the following order number can be used for this:

Order number:
06028-2-167



Figure 52

18.1.4 LIGHTING WITH WARNING SIGNS (ON BOTH SIDES)

Warning signs with lighting are available as accessories for the Grassland Pro Harrow. These signs are required when the implement is transported in road traffic.

The lighting / warning signs are also available separately, the following order number can be used for this:

Order number:
06028-2-248



Figure 53

18.1.5 MUDGUARD

The mudguards are also available separately, the following order number can be used for this:

Order number:

Tyre dimension 500/50-17": 06028-2-247

Tyre dimension 400/60-15.5" and 12.5"/80-18": 06028-2-216

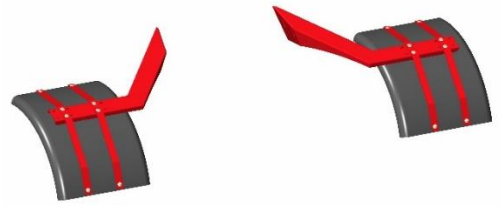

Figure 54: Symbolic image

18.1.6 ANTI-THEFT DEVICE

The anti-theft device is also available separately, the following order number can be used for this:

Order number:

06028-2-262

18.2 MOUNTING KIT FOR PS200 - 500

This bracket is used to mount a PS 200 – PS 500 Pneumatic Seeder on the implement. Please note that it must be mounted in compliance with the standards.

Order number:

06028-2-278



Figure 55

18.3 DISPERSION PLATE INSTALLATION

This is used to attach the dispersion plates on the Grassland Pro Harrow.

Order number:

For 8 outlets: 06028-2-276

For 16 outlets: 06028-2-277



Figure 56: Symbolic image

18.4 MOUNTING KIT FOR PS 800

This bracket is used to mount a PS 800 Pneumatic Seeder on the implement. Please note that it must be mounted in compliance with the standards.

Order number:

06028-2-279

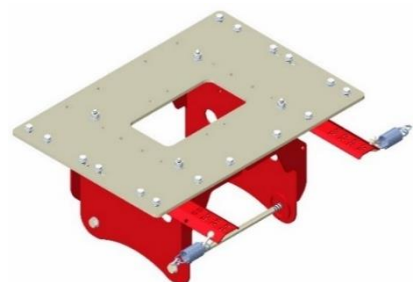

Figure 57

18.5 PLATFORM KIT

A suitable platform kit is available as an accessory for easier maintenance of the PS 200 – PS 800 Pneumatic Seeder. Please note that it must be mounted in compliance with the standards.

Order number:
06028-2-275

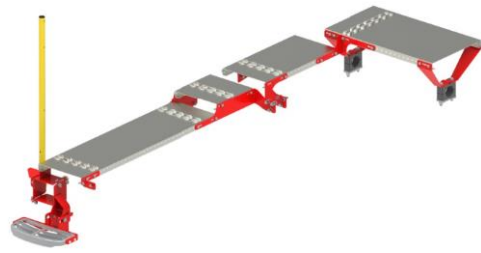

Figure 58

18.6 CHANGEOVER VALVE FOR OPERATING TWO HYDRAULIC FUNCTIONS

The changeover valve enables connection of the hydraulic circuits of the roller frame and the chassis. As a result, one less control unit is required. Switching between the two hydraulic circuits is achieved by actuating the lever on the changeover valve, which is attached to the drawbar (see Figure 59).

Order number:
06028-2-239



Figure 59

18.7 TOOLBOX

Order number:
06028-2-283



Figure 60

18.8 SENSOR SET: GPSA + LINKAGE SENSOR

The GPSa sensor transmits the current vehicle speed to the Control Box so that the seed rate is automatically regulated. It is installed on the seeder hopper.

The linkage sensor / hydraulic sensor interrupts the metering on the headland. The sensor is installed in the hydraulic line of the roller cylinder.

Order number:
06028-2-280





TIP!

Before driving off for the first time, calibrate the speed on the Control Box 5.2.



Figure 61

18.9 FEELER WHEEL MOUNTING KIT

This kit is required if you want to mount or dismount the roller of the GP. It consists of:

- Supports for the side frames
- A manoeuvring aid for the rollers and
- Feeler wheels.

The supports are installed on the side frames. This means that the weight of the implement does not rest on the tines and more space is available for coupling and uncoupling the rollers.

The manoeuvring aid is hooked in on the roller frame at the coupling point of the hydraulic cylinder. It acts as type of drawbar to move the roller away from the implement (uncoupling) or towards the implement (coupling) without exertion using a towing vehicle (e.g. yard loader, tractor or forklift). A position indicator on the manoeuvring aid facilitates coupling of the roller.

The rollers must be replaced by feeler wheel pairs. This ensures uniform depth guidance of the tools.

Order number:

06028-2-281



Figure 62

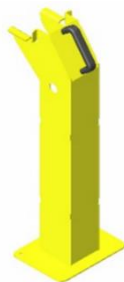

Figure 63: Support



Figure 64: Feeler wheels



Figure 65: Manoeuvring aid



Figure 66: Manoeuvring aid

19 SPARE PARTS

You have the option to order your required spare parts directly through our online spare parts catalogue. To do so, scan the QR code with your smartphone - you will be taken directly to our online spare parts catalogue. Please keep your product number / serial number at hand.

You can also view our online spare parts catalogue on our website www.apv.at in the Service area.

If you have any questions regarding spare parts or your order, our Customer Service (see point 4 Servicefor contact data) is also happy to assist you.



20 INDEX

Accident prevention regulations.....	8	Loading and unloading.....	27
Adjusting the series of holes.....	24	Lubrication points.....	30
Bearing.....	35	Lubrication schedule.....	30
Bracket for PS.....	40	Maintenance.....	28
Changing the tines.....	29	Mode of operation of the implement.....	19
Combination options.....	33	Operating Manual.....	19
Compressed air system defective.....	37	Parking support.....	21
Connection of the compressed air system.....	37	Platform kit.....	41
Connection of the hydraulic hoses.....	10, 20	Production number.....	6
Connection of the pneumatic brake system ...	20, 22	Recyclable raw materials.....	32
Coupling the implement.....	20	Repair.....	31
Cropping tips.....	36	Road transport.....	33
Decommissioning.....	35	Roller.....	25
Disposal.....	36	Safety information.....	7
Drawbar adjustment.....	23	Service.....	6, 31
EC Declaration of Conformity.....	4	Service address.....	6
Energy-efficient use.....	32	Shear-off safety.....	25
Folding.....	23	Spare parts.....	43
Folding lock.....	26	Technical data.....	32
GPSa sensor.....	41	Tine safety.....	30
Hydroclips.....	23	Turning.....	27
Identification.....	6	Type designation.....	32
Information signs.....	16	Type plate.....	6
Intended use.....	7	Tyre pressures.....	29
Lashing points.....	27	Uncoupling the implement.....	21
Layout of the implement.....	19	Unfolding.....	22
Levelling plate.....	24	Warning sign with lighting.....	39
Lighting.....	35	Warranty.....	7
Linkage sensor.....	41	Warranty activation.....	7
		Working depth.....	23



APV – Technische Produkte GmbH
Zentrale: Dallein 15
AT - 3753 Hötzelendorf

Tel.: +43 2913 8001
office@apv.at
www.apv.at

